

## Mehrfaltenbalg

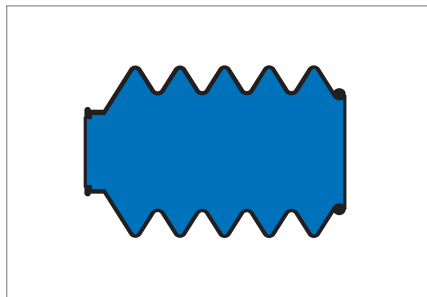

### Produktbeschreibung

Faltenbälge sind Schutzelemente, bestehend aus beweglichem Balgteil und zwei Anschlussbereichen zur Befestigung. Sie schützen axial bewegte Stangen und Maschinenteile vor Verschmutzung, Spritzwasser, Staub oder Witterungseinflüssen. Sie sind je nach Auslegung in der Lage, auch quer zur Achsrichtung verlaufende Bewegungen oder eine Kombination von beiden Bewegungsarten (z.B. Getriebebeschalthebel) aufzunehmen.

Bälge können innerhalb der Grenzwerte  $L_{\min}$  (zusammengedrückte Länge) und  $L_{\max}$  (ausgezogene Länge) axialen Bewegungen folgen. Besondere Belastungen (nicht axiale Bewegungen, Druckbelastungen usw.) beeinflussen den maximalen Arbeitshub und die Beweglichkeit. → Technisches Handbuch.

### Produktvorteile

Balgteil und Anschlussbereiche haben je nach Einsatzfall die unterschiedlichsten geometrischen Formen und Abmessungen. Mehr als 500 unterschiedliche Balggeometrien stehen dem Anwender schnell und kostengünstig zur Verfügung.

### Anwendungsbereich

Für Faltenbälge gibt es zahlreiche Einsatzfälle; beispielsweise das funktionelle Abdichten von Kugelgelenken, Verbindung von Rohrenden, Schubstangen (z.B. in Hydraulik- und Pneumatikanwendungen), Achslagern.

### Werkstoff

Werkstoff	Härte
CR	42/50 Shore A
NBR	ca. 45 Shore A

Andere Werkstoffe auf Anfrage. (Nach Abklärung des Werkstoff-Anforderungsprofils und der Bauform).

### Einsatzbereich

Werkstoff	Temperatur	Dynamische Beanspruchung	Mineralöl- und Fettbeständigkeit
CR	-40 ... +100 °C	sehr gut	ausreichend
NBR	-30 ... +100 °C	ausreichend	gut

Bei den in der Tabelle aufgeführten Werten handelt es sich um Richtwerte. → Technisches Handbuch.

### Einbau und Montage

Der bewegliche Balgteil darf nicht mit scharfen Kanten in Berührung kommen. Ständiges Schleifen an bewegten Maschinenteilen ist unbedingt zu vermeiden. Bälge können keine wesentlichen Über- oder Unterdrücke aufnehmen, da sonst eine zu starke Verformung eintreten würde. Um einen Druckaufbau im Inneren des Balges bei axialen Bewegungen zu verhindern, muss eine ausreichende Be- und Entlüftung vorgesehen werden. Eine Belastung des Balges durch Torsion sollte vermieden werden. Weitere Hinweise zum Einbau: → Technisches Handbuch.

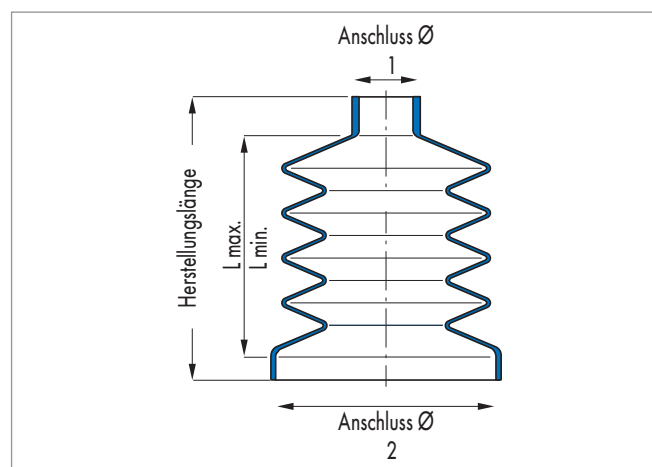

Maßskizze Mehrfaltenbalg

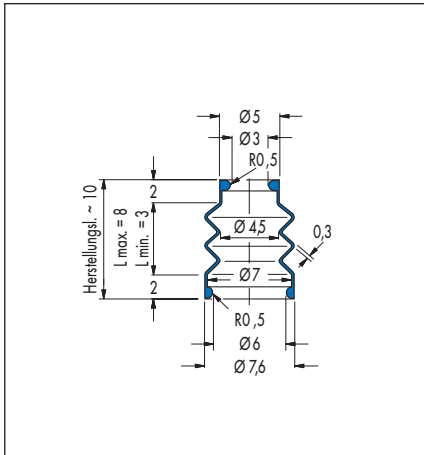

V6-00748, Artikel-Nr. 29944

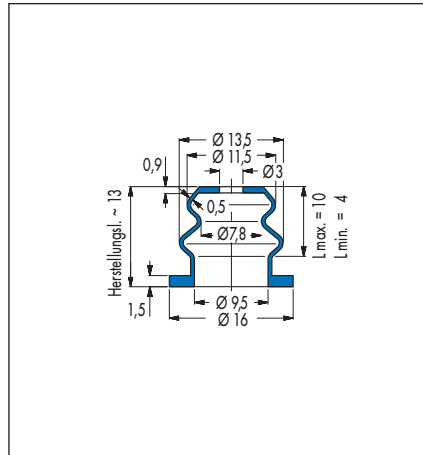

V6-00618, Artikel-Nr. 29785

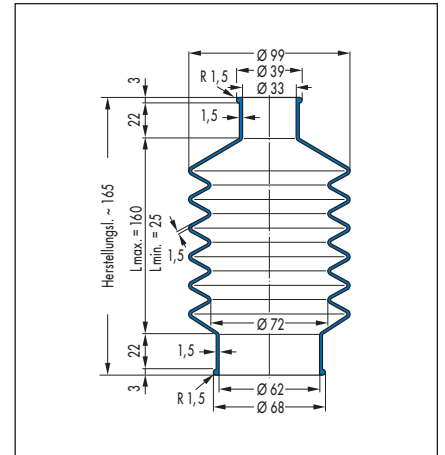

V6-00694, Artikel-Nr. 466184

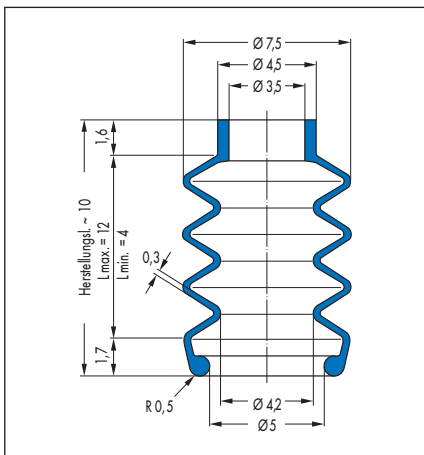

V6-01109, Artikel-Nr. 5417

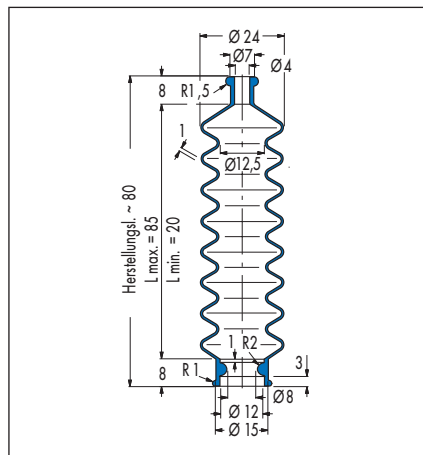

V6-00249, Artikel-Nr. 438531

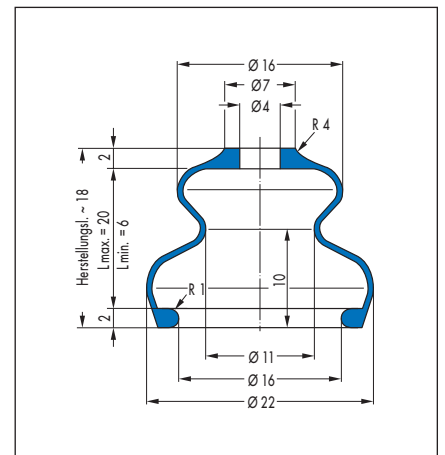

V6-01231, Artikel-Nr. 8934

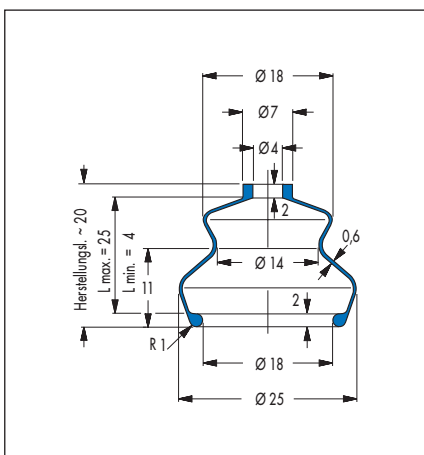

V6-00949, Artikel-Nr. 435

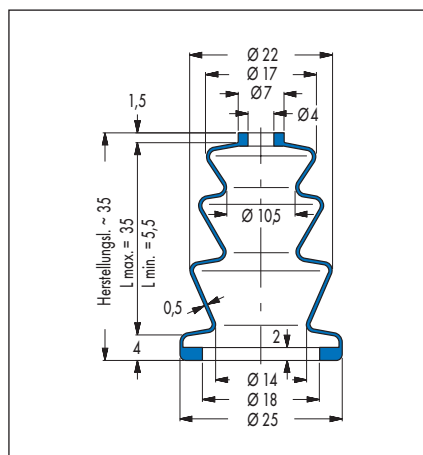

V6-01008, Artikel-Nr. 14405

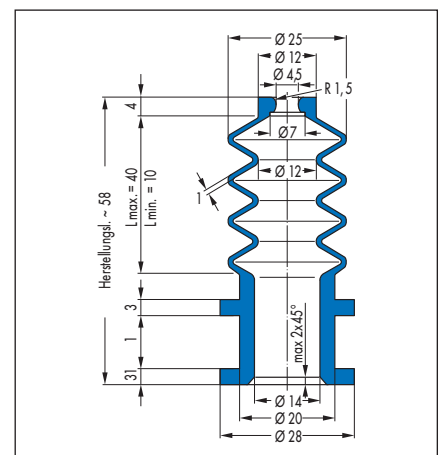

V6-01281, Artikel-Nr. 389744

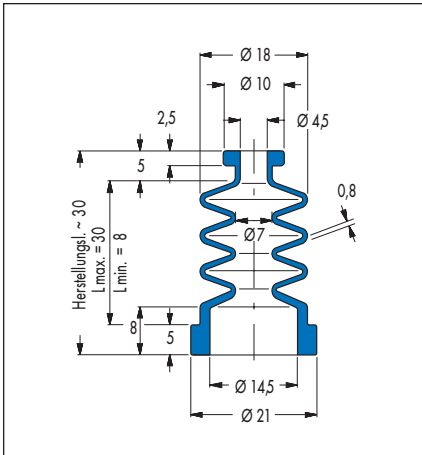

V6-00055, Artikel-Nr. 29209

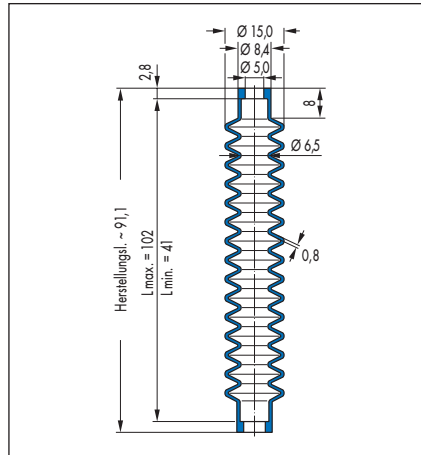

V6-20138, Artikel-Nr. 420271

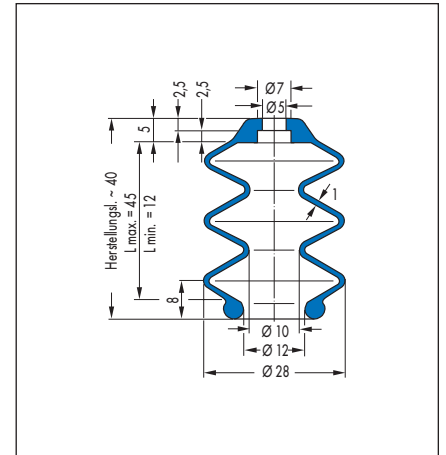

V6-00322, Artikel-Nr. 439472

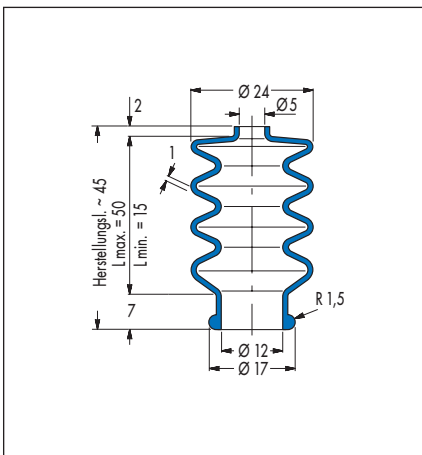

V6-00258, Artikel-Nr. 438028

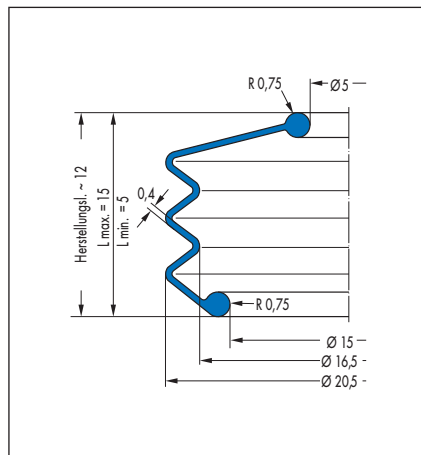

V6-01207, Artikel-Nr. 452568

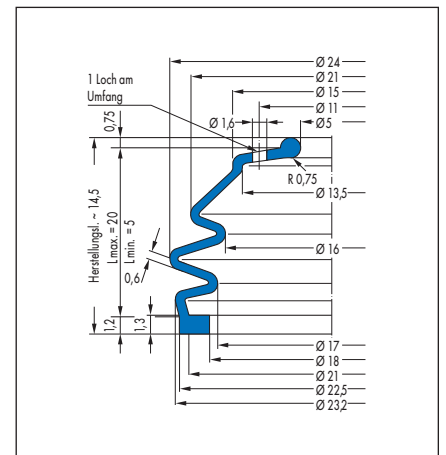

V6-01194, Artikel-Nr. 440258

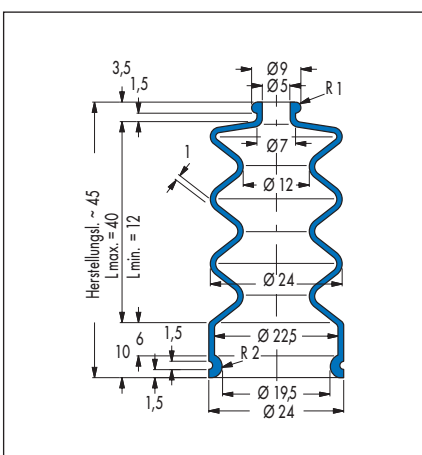

V6-00358, Artikel-Nr. 435291

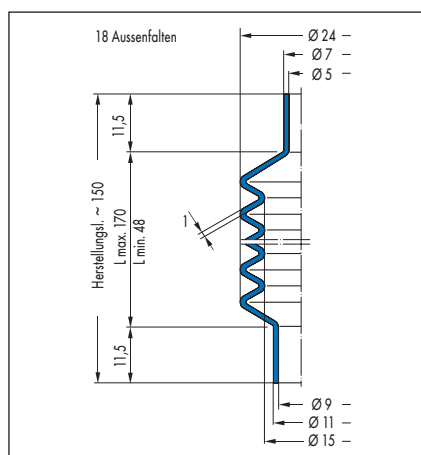

V6-00931, Artikel-Nr. 440334

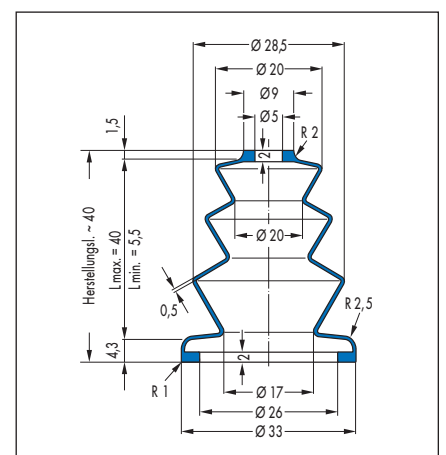

V6-01009, Artikel-Nr. 456494

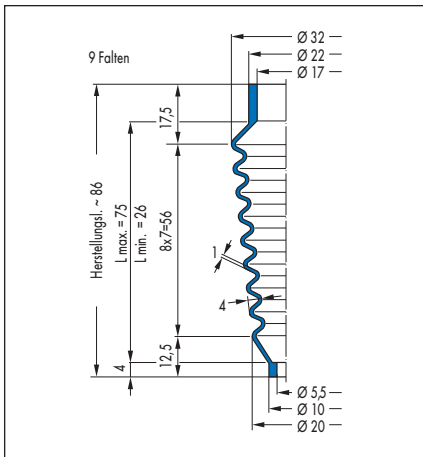

V6-01466, Artikel-Nr. 457512

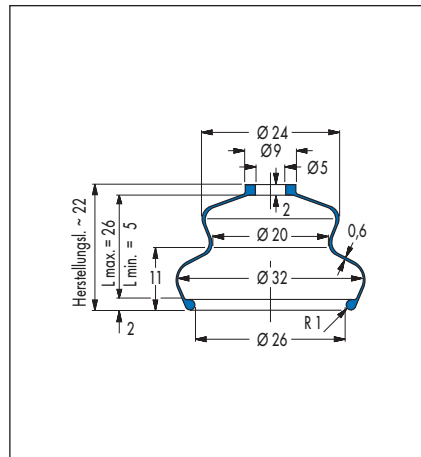

V6-00948, Artikel-Nr. 434 (42 CR 764)/  
420983 (50 CR 879)

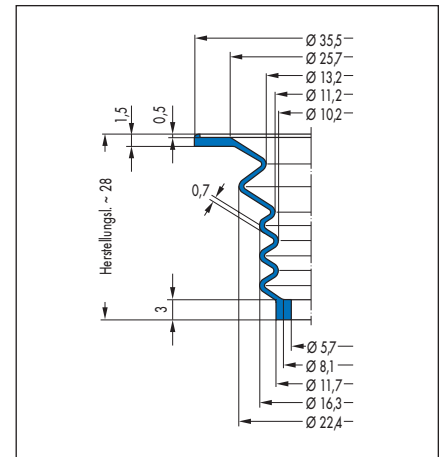

V6-01526, Artikel-Nr. 400999

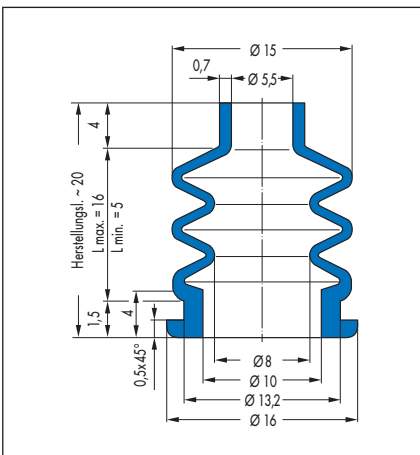

V6-20104, Artikel-Nr. 400549

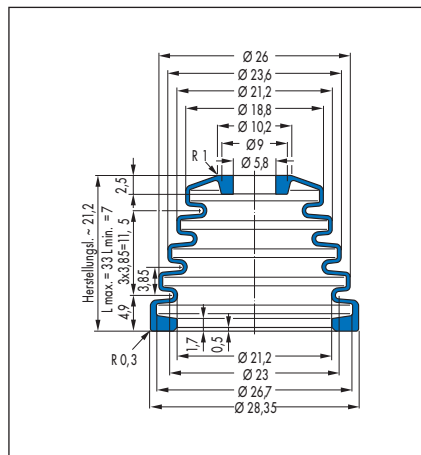

V6-20134, Artikel-Nr. 453832

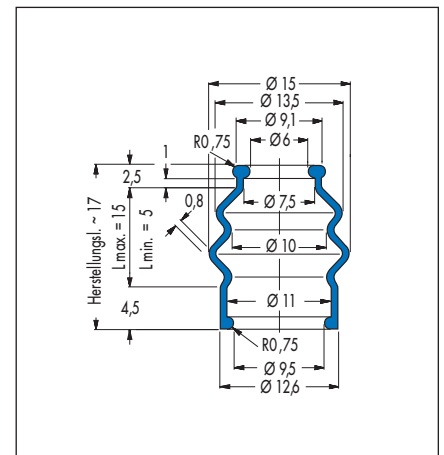

V6-00752, Artikel-Nr. 428864

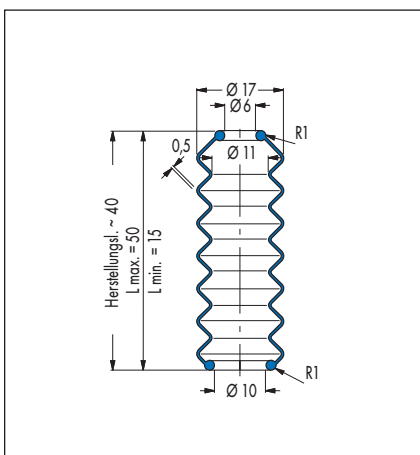

V6-00169, Artikel-Nr. 438526

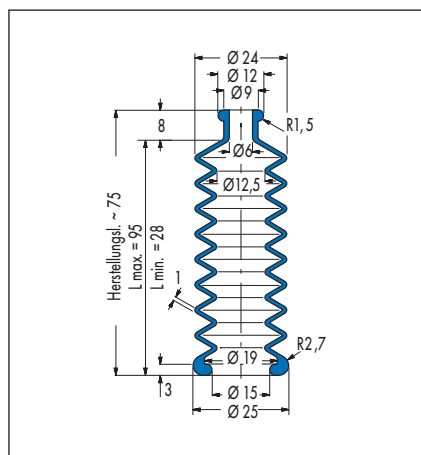

V6-00126, Artikel-Nr. 435526

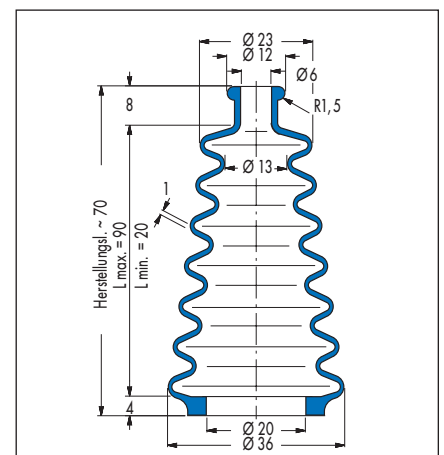

V6-00167, Artikel-Nr. 438520

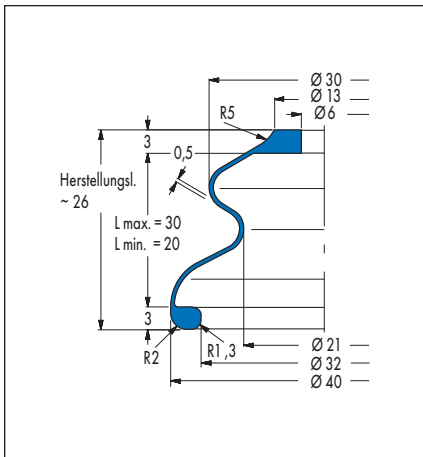

V6-01104, Artikel-Nr. 434028

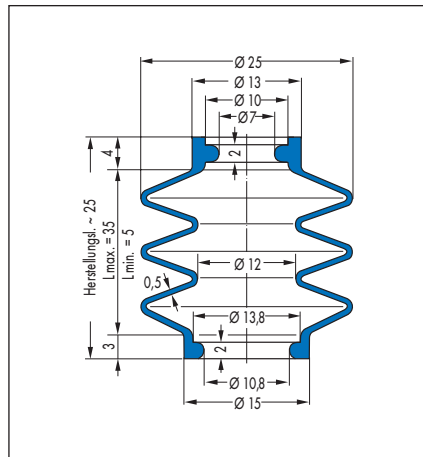

V6-00471, Artikel-Nr. 507077

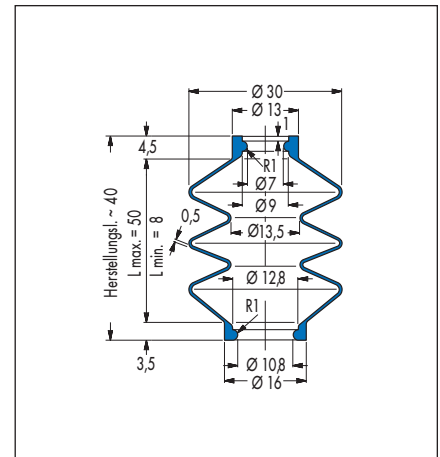

V6-00525, Artikel-Nr. 438219 (45 NBR 670)/  
438221 (42 CR 764)

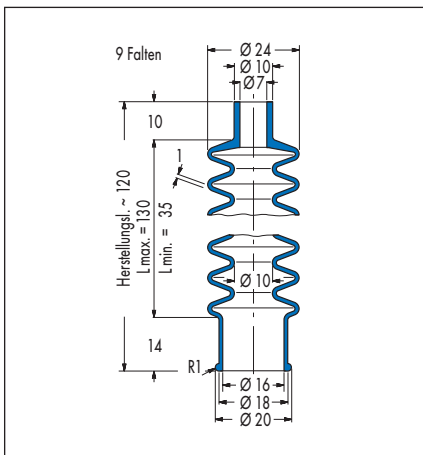

V6-00269, Artikel-Nr. 438534

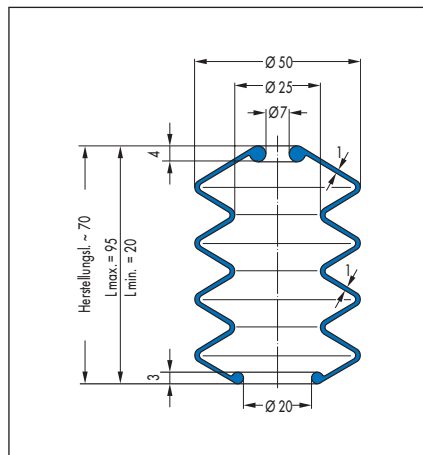

V6-01150, Artikel-Nr. 142815

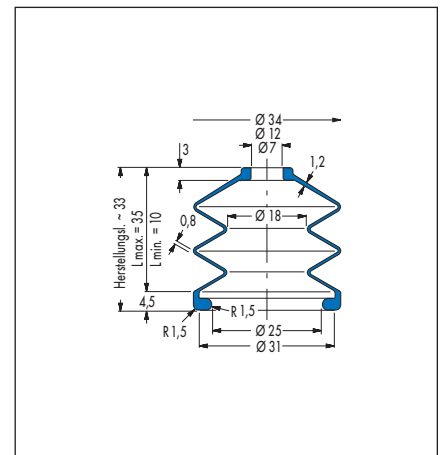

V6-00875, Artikel-Nr. 5530

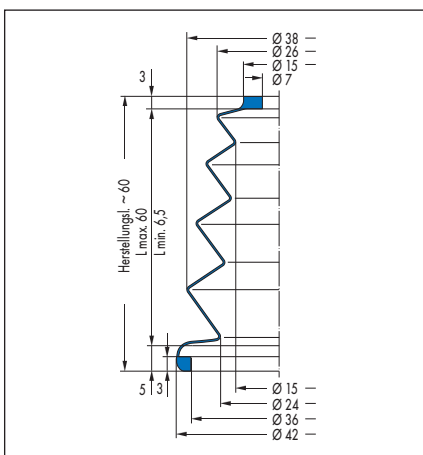

V6-01011, Artikel-Nr. 400903

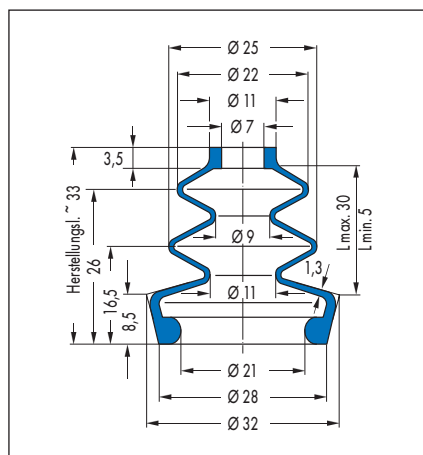

V6-01032, Artikel-Nr. 402606

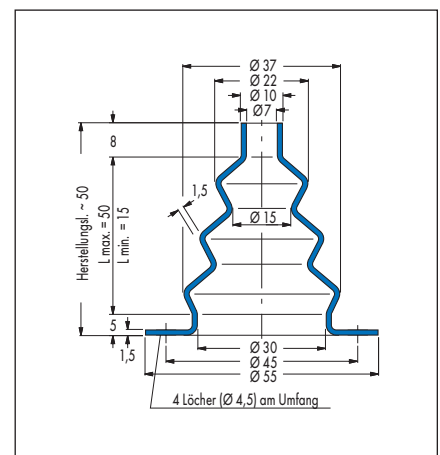

V6-00795, Artikel-Nr. 451753

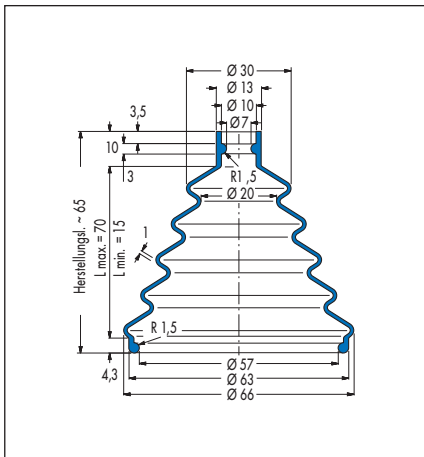

V6-00600, Artikel-Nr. 438545

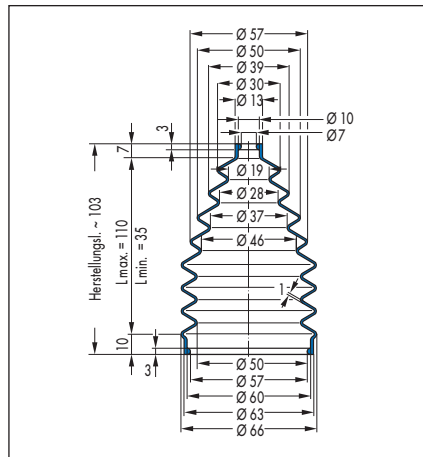

V6-20122, Artikel-Nr. 452810

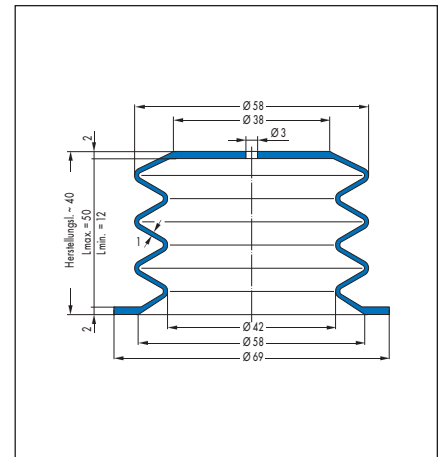

V6-00735, Artikel-Nr. 456487

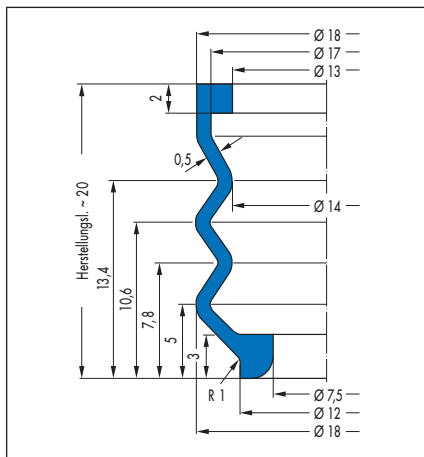

V6-01408, Artikel-Nr. 400989

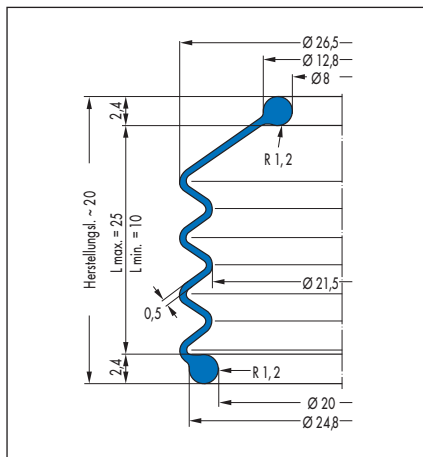

V6-01052, Artikel-Nr. 81226

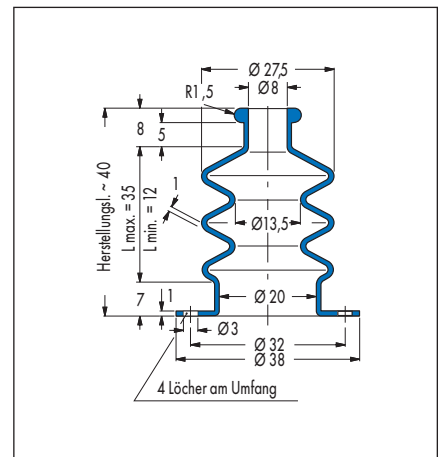

V6-00307, Artikel-Nr. 29502

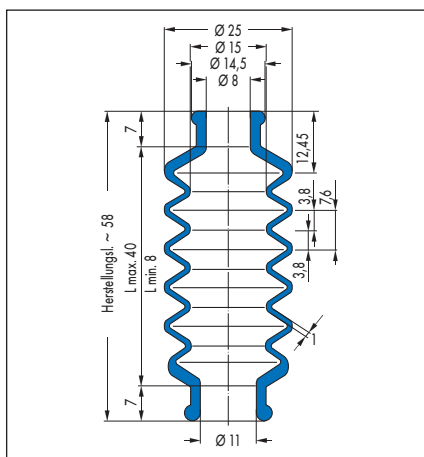

V6-00257, Artikel-Nr. 439218

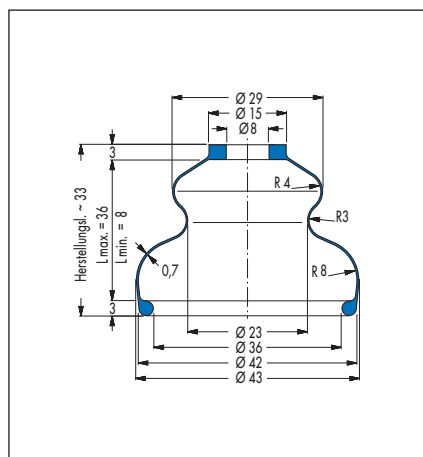

V6-00947, Artikel-Nr. 436933

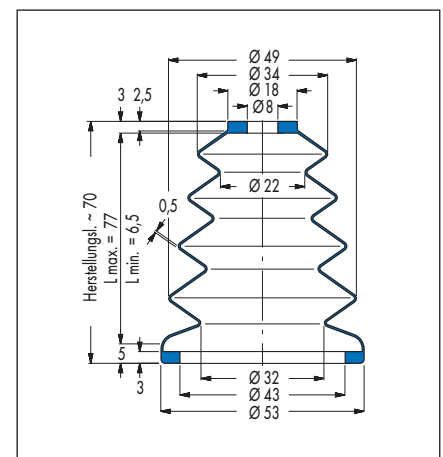

V6-01012, Artikel-Nr. 453786

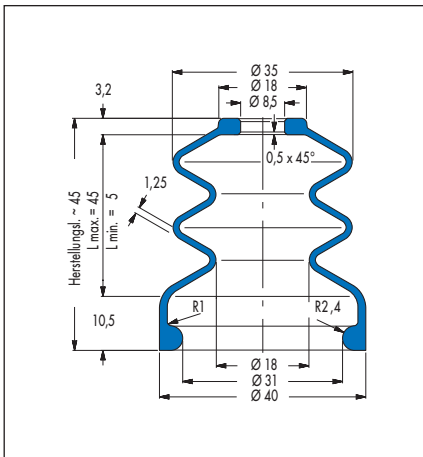

V6-01138, Artikel-Nr. 428843

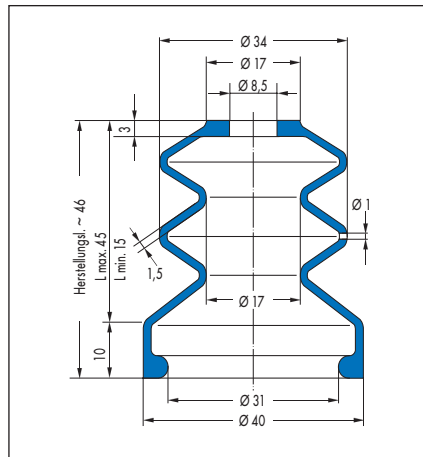

V6-00802, Artikel-Nr. 400840

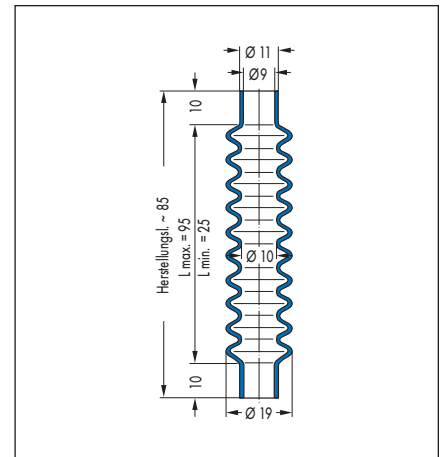

V6-00338, Artikel-Nr. 439491

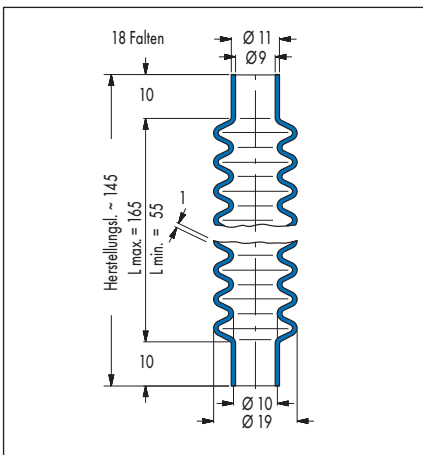

V6-00337, Artikel-Nr. 439492

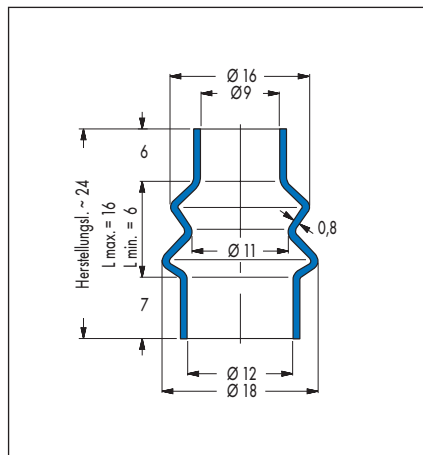

V6-00336, Artikel-Nr. 439483

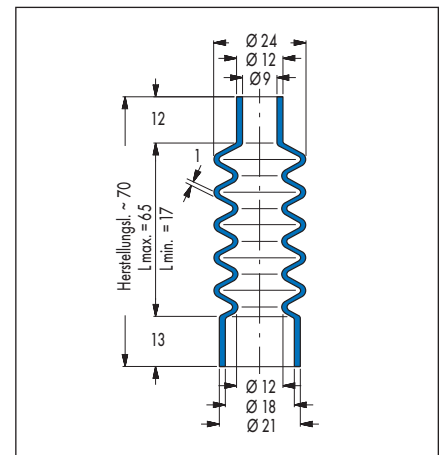

V6-00225, Artikel-Nr. 428314

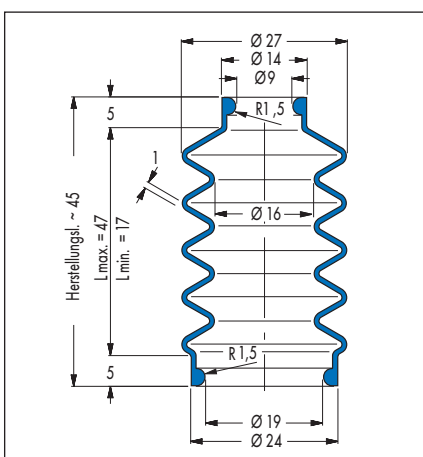

V6-00724, Artikel-Nr. 438552

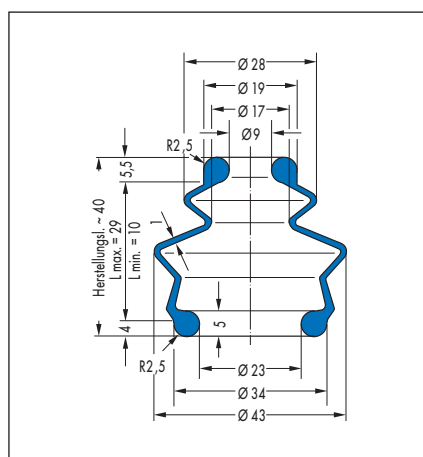

V6-00015, Artikel-Nr. 439217

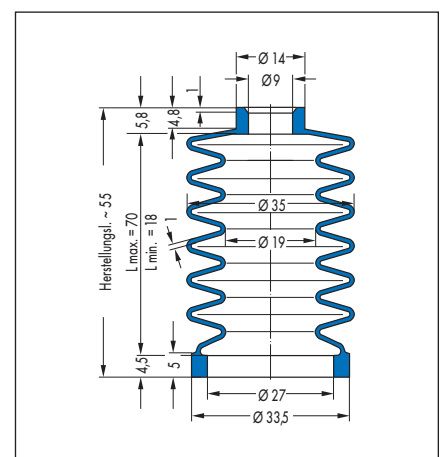

V6-00261, Artikel-Nr. 439215

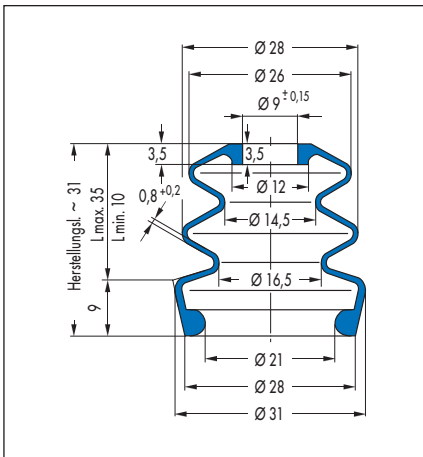

V6-00914, Artikel-Nr. 400890

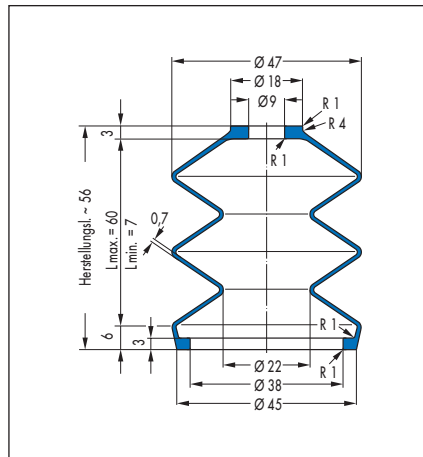

V6-00996, Artikel-Nr. 457508

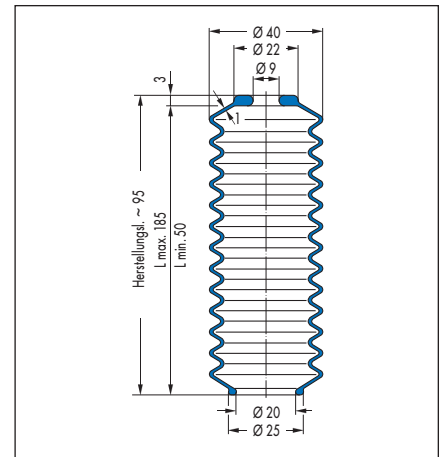

V6-00898, Artikel-Nr. 400886

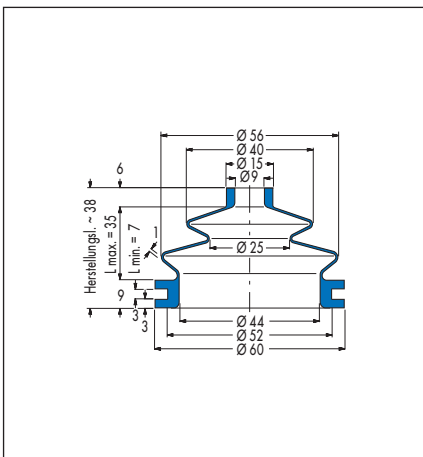

V6-00800, Artikel-Nr. 435516

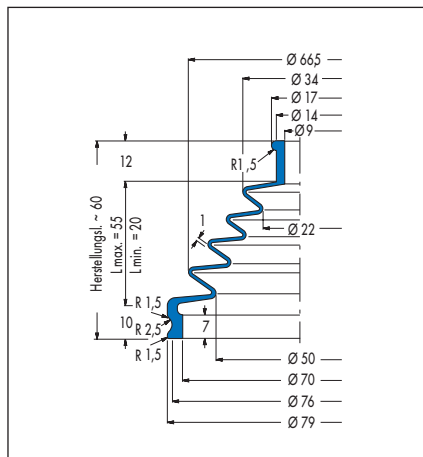

V6-00729, Artikel-Nr. 432997

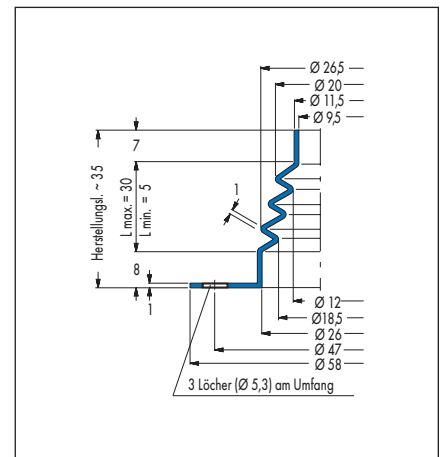

V6-00665, Artikel-Nr. 426800

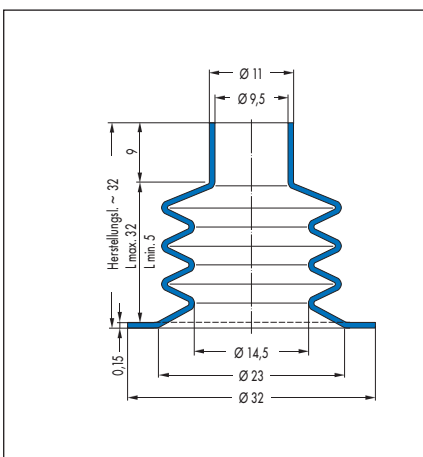

V6-00107, Artikel-Nr. 439216

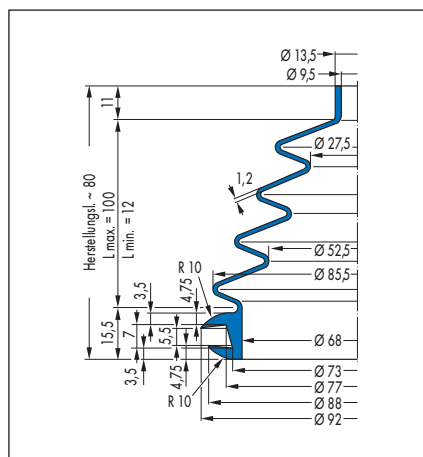

V6-00764, Artikel-Nr. 380287

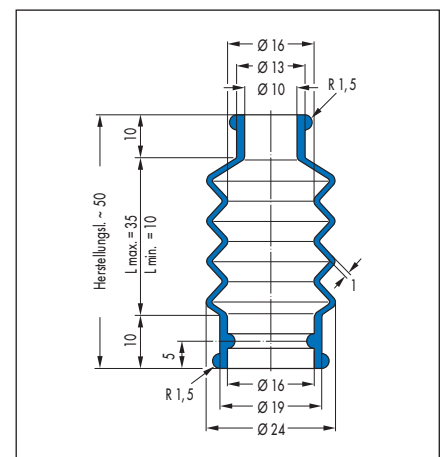

V6-01745, Artikel-Nr. 436919



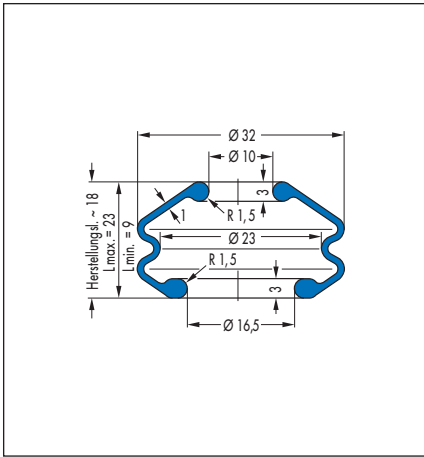

V6-00438, Artikel-Nr. 29634

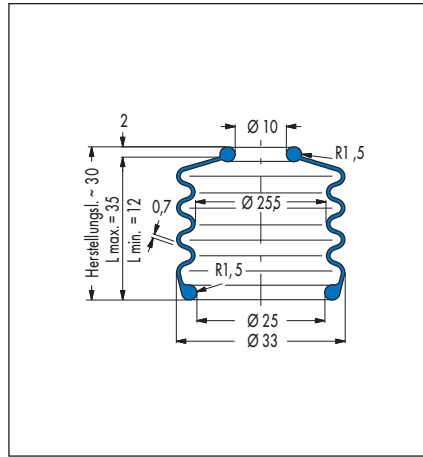

V6-00554, Artikel-Nr. 438537

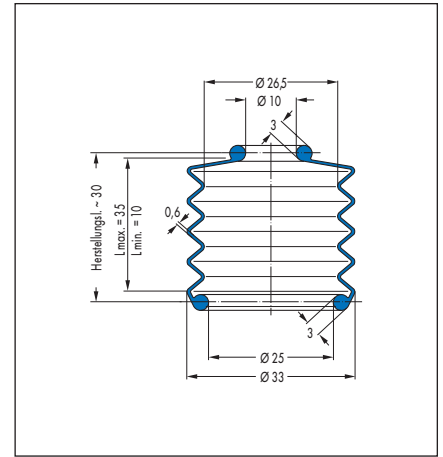

V6-00979, Artikel-Nr. 5810

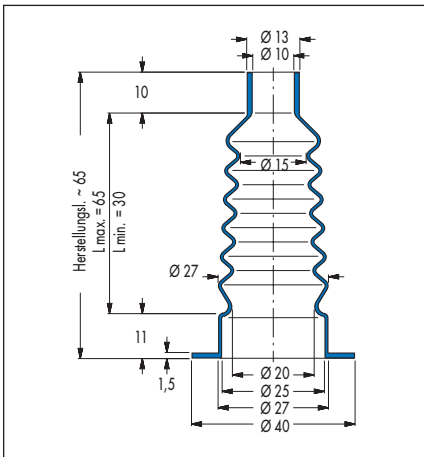

V6-00052, Artikel-Nr. 432593

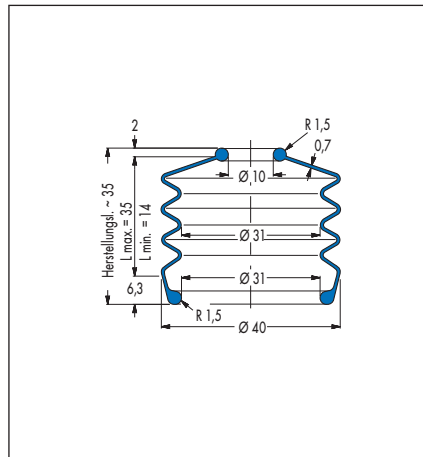

V6-00555, Artikel-Nr. 438572

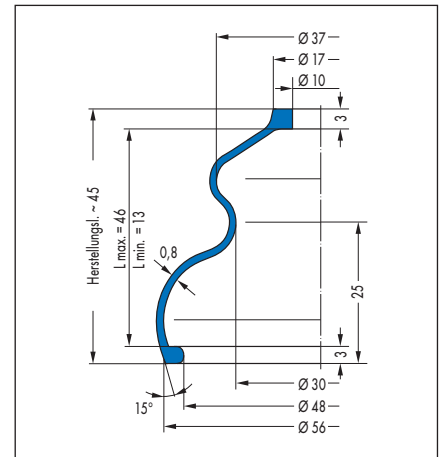

V6-00945, Artikel-Nr. 413

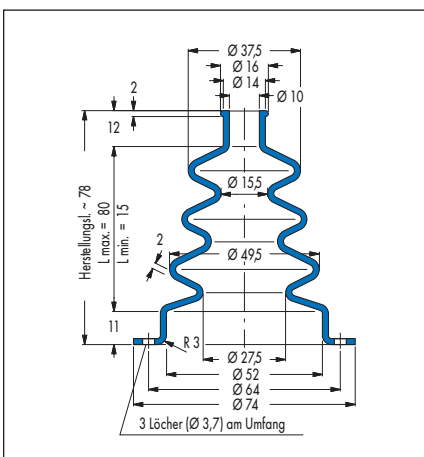

V6-01348, Artikel-Nr. 429741 (50 CR 879)/  
430248 (42 CR 764)

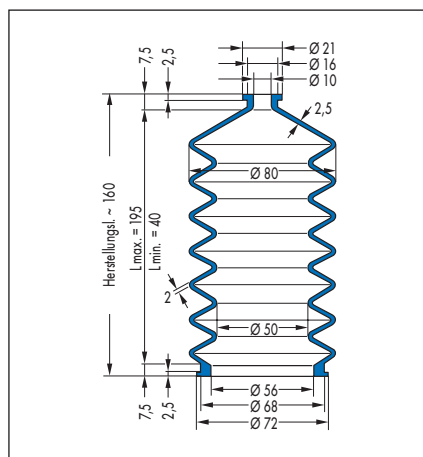

V6-00741, Artikel-Nr. 456488

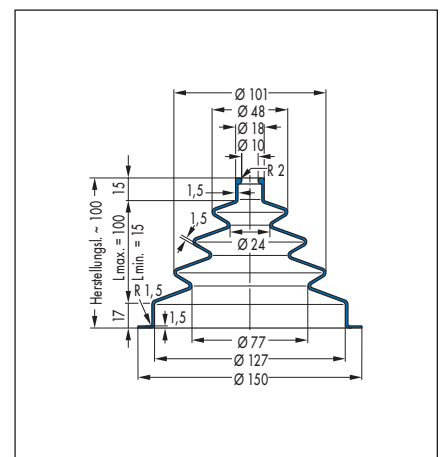

V6-00793, Artikel-Nr. 122760

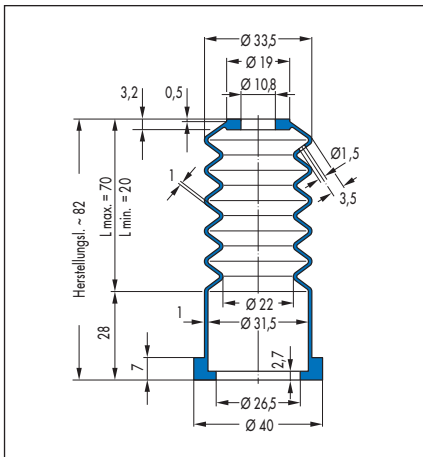

V6-01119, Artikel-Nr. 400940

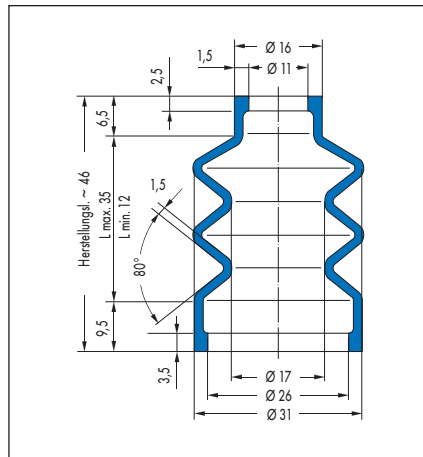

V6-00833, Artikel-Nr. 400864

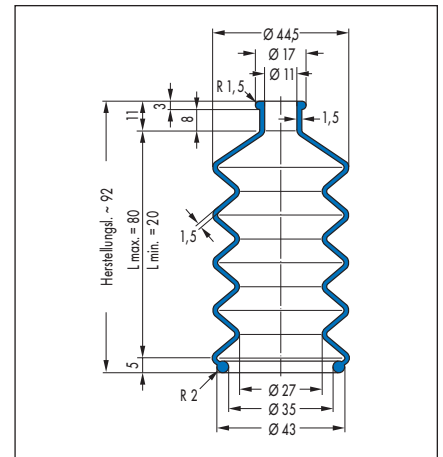

V6-00829, Artikel-Nr. 507862

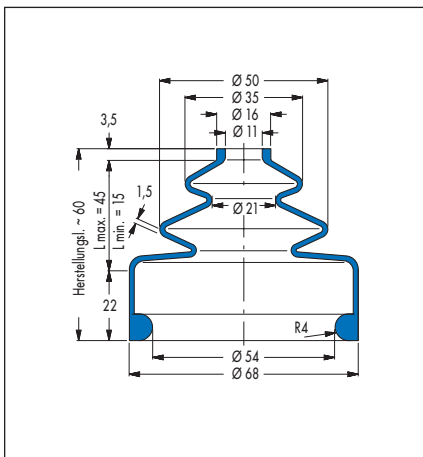

V6-00111, Artikel-Nr. 434031

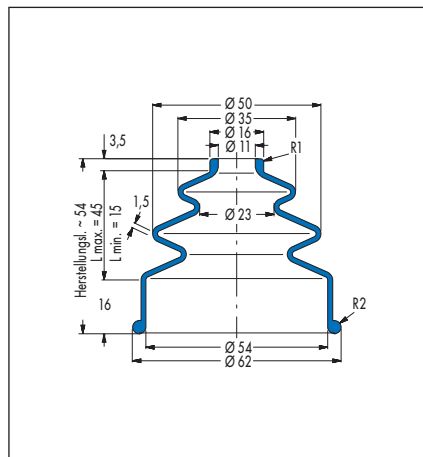

V6-00320, Artikel-Nr. 440257

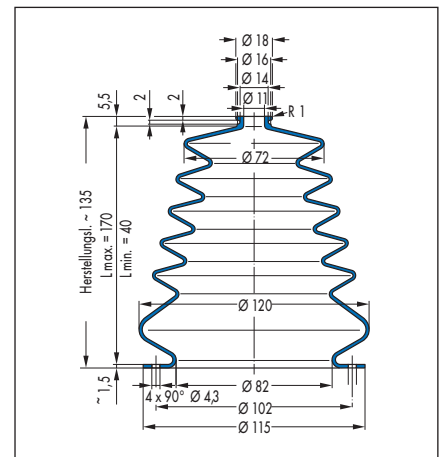

V6-01218, Artikel-Nr. 454250

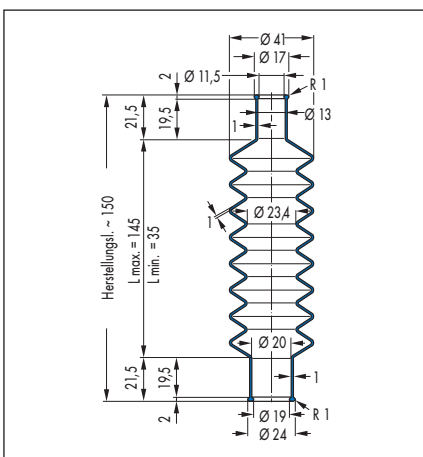

V6-00836, Artikel-Nr. 400869

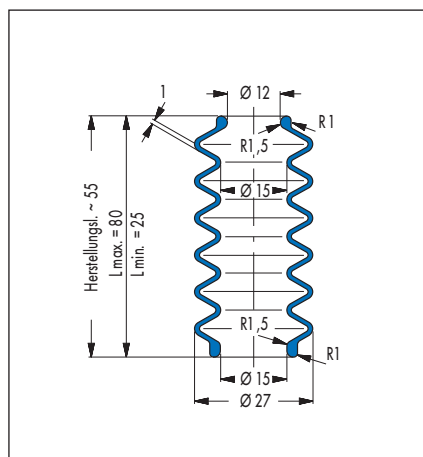

V6-00158, Artikel-Nr. 430845

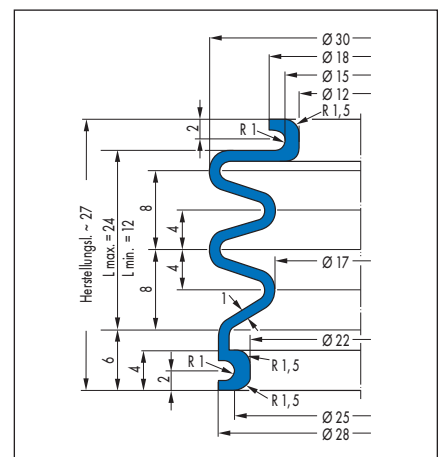

V6-01725, Artikel-Nr. 370363

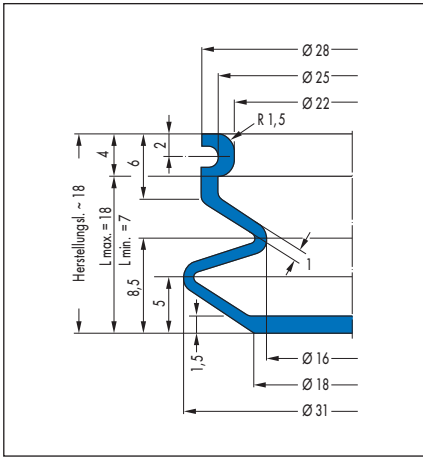

V6-01724, Artikel-Nr. 357997

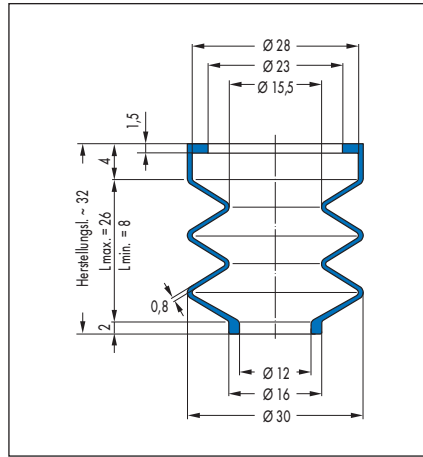

V6-01585, Artikel-Nr. 365460

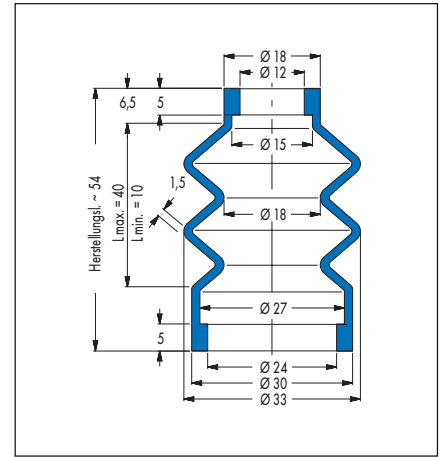

V6-00288, Artikel-Nr. 452930

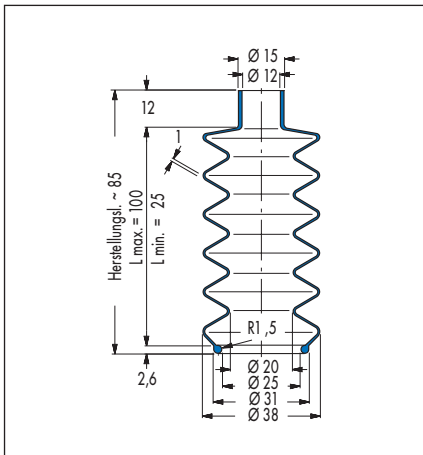

V6-00650, Artikel-Nr. 428275

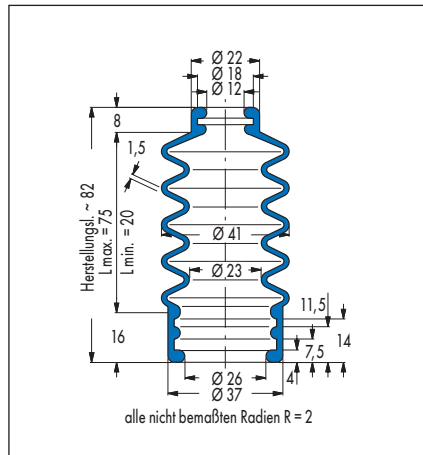

V6-00022, Artikel-Nr. 29192

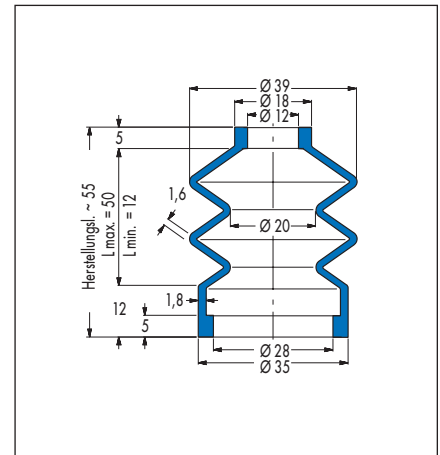

V6-00289, Artikel-Nr. 439474

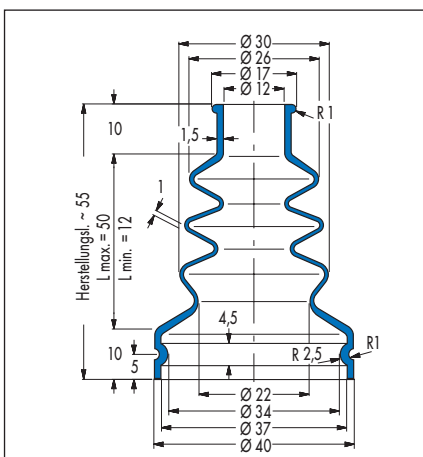

V6-00716, Artikel-Nr. 427272

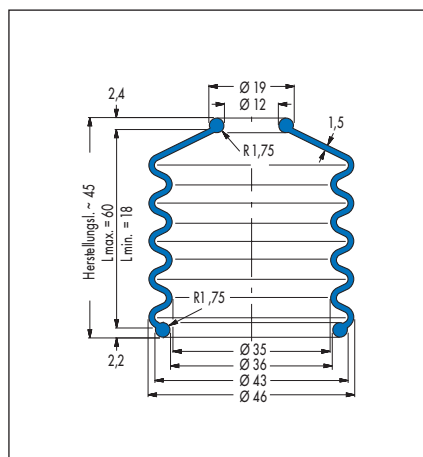

V6-00880, Artikel-Nr. 438558

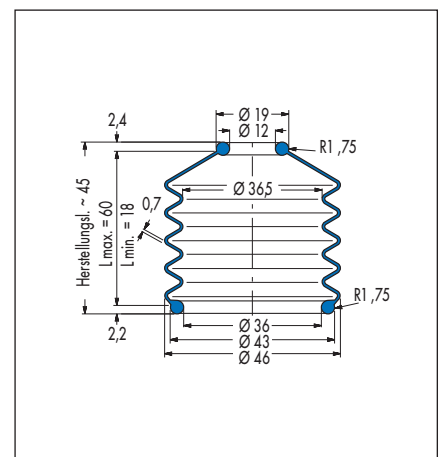

V6-00580, Artikel-Nr. 66382 (50 CR 879)/  
81222 (42 CR 764)

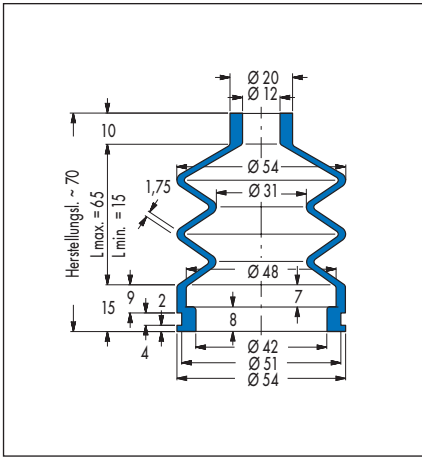

V6-00423, Artikel-Nr. 435215

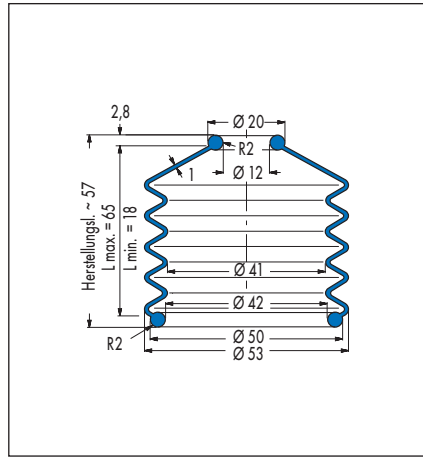

V6-00581, Artikel-Nr. 438541 (CR)/  
438542 (NBR)

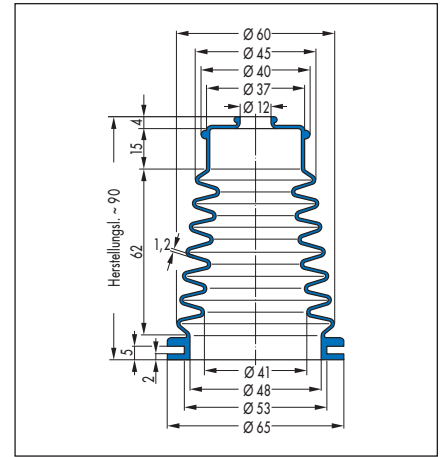

V6-00859, Artikel-Nr. 31869

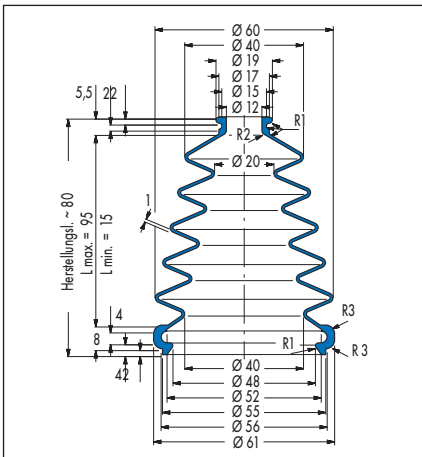

V6-00625, Artikel-Nr. 438216

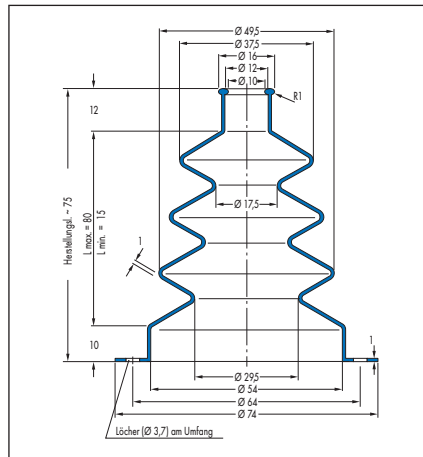

V6-00631, Artikel-Nr. 426386

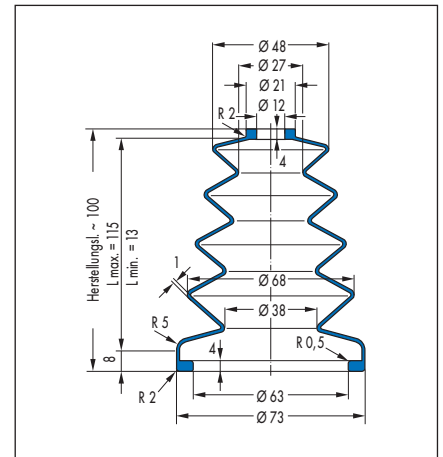

V6-01014, Artikel-Nr. 454262

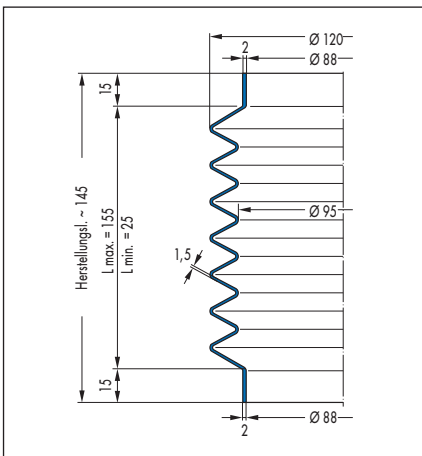

V6-01261, Artikel-Nr. 454481

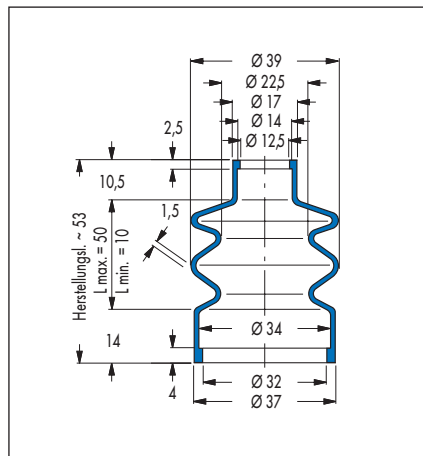

V6-00816, Artikel-Nr. 434459

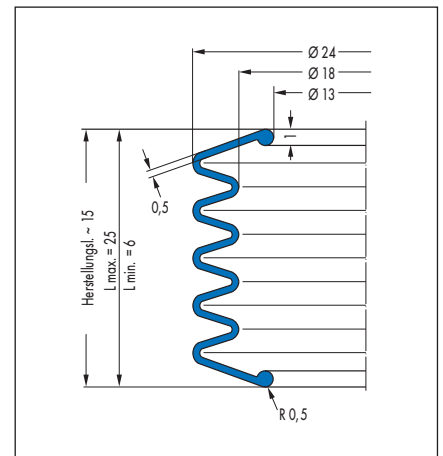

V6-00989, Artikel-Nr. 117054

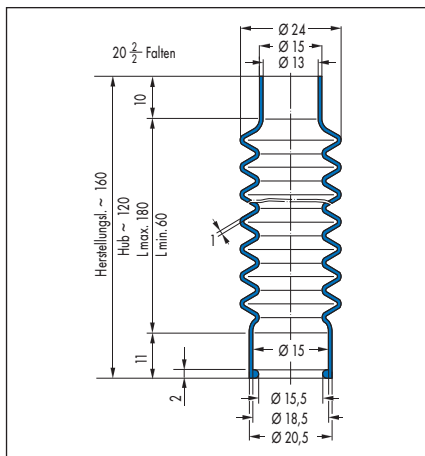

V6-00930, Artikel-Nr. 400893

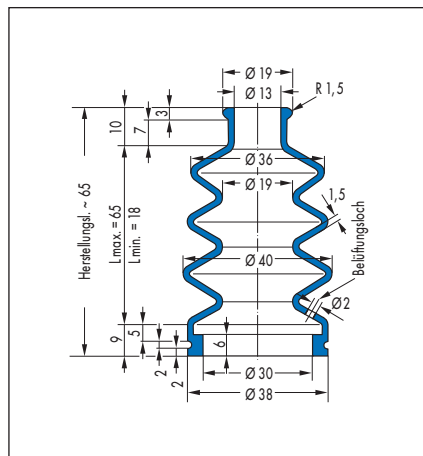

V6-00505, Artikel-Nr. 453725

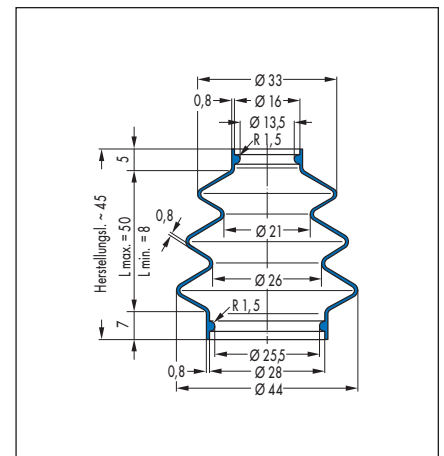

V6-00616, Artikel-Nr. 400781

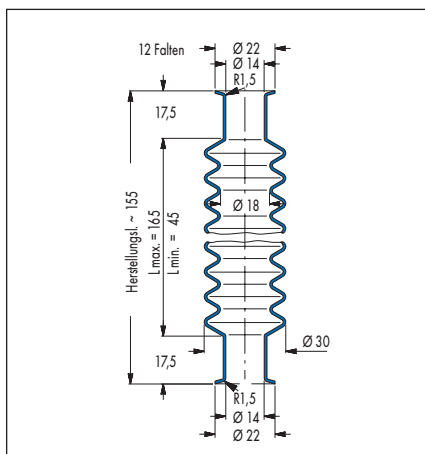

V6-00237, Artikel-Nr. 427261

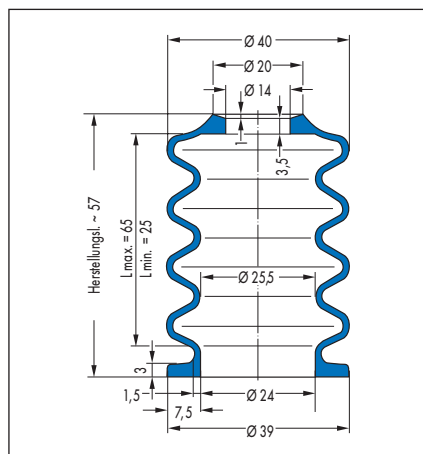

V6-00439, Artikel-Nr. 29637

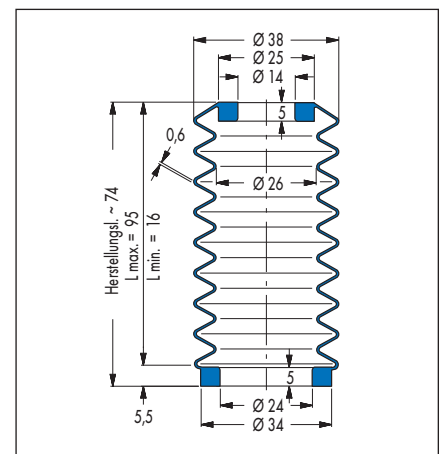

V6-00905, Artikel-Nr. 428836, 437671  
(42 CR 764)

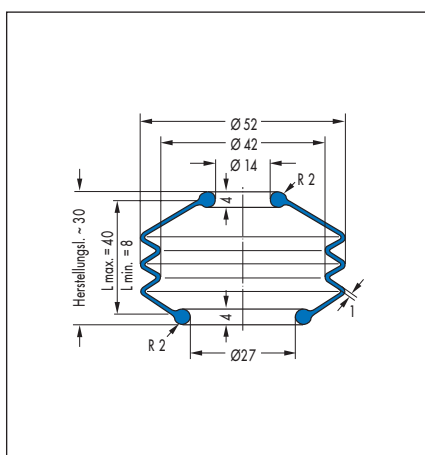

V6-00644, Artikel-Nr. 400787

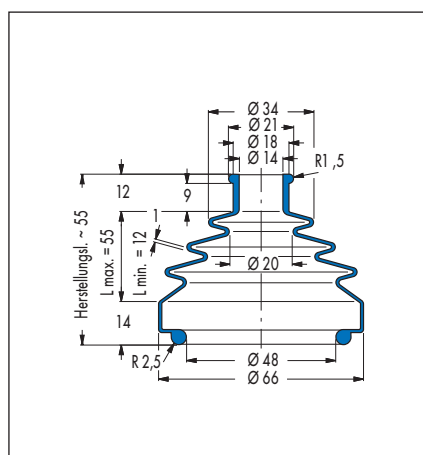

V6-00585, Artikel-Nr. 436695 (50 CR 879)/  
436697 (42 CR 764)

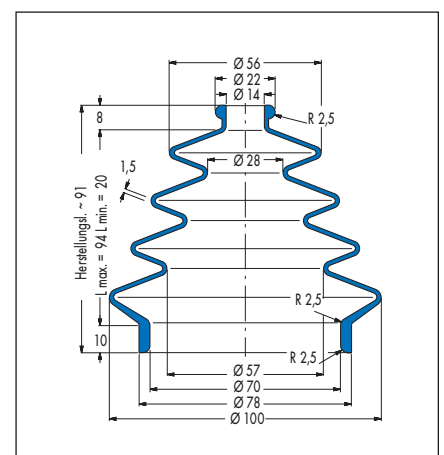

V6-01358, Artikel-Nr. 451650

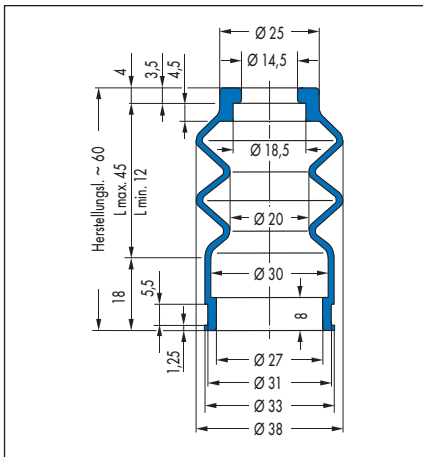

V6-00189, Artikel-Nr. 440390

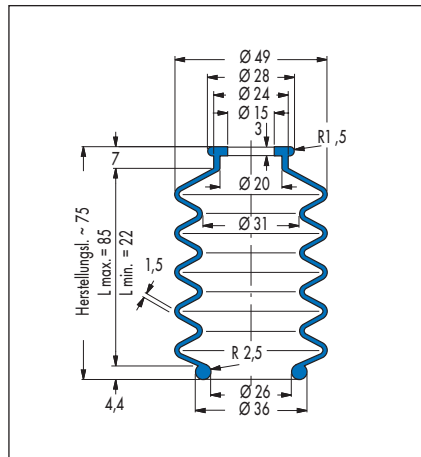

V6-00488, Artikel-Nr. 426793

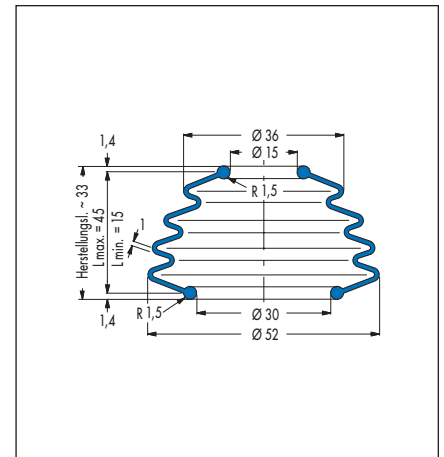

V6-00277, Artikel-Nr. 435217

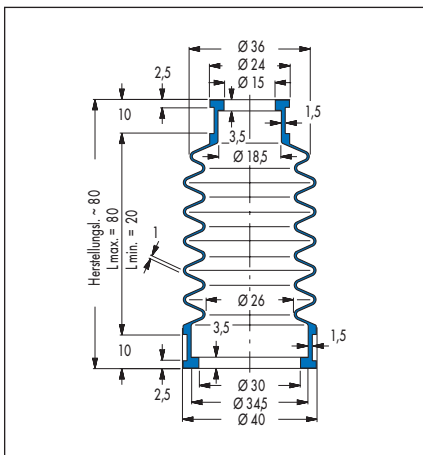

V6-00156, Artikel-Nr. 436158

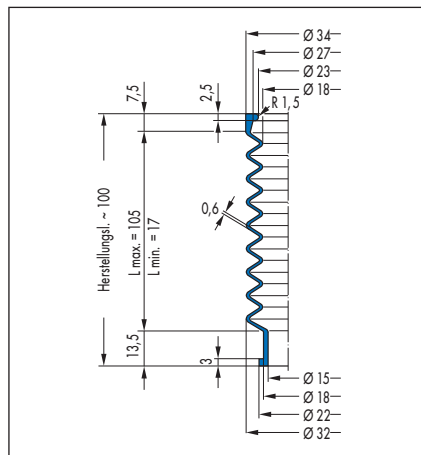

V6-01450, Artikel-Nr. 452567

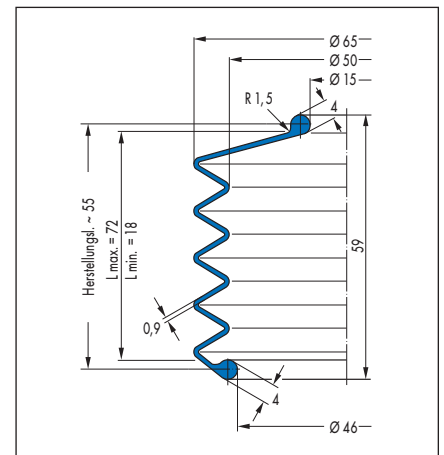

V6-01538, Artikel-Nr. 434075

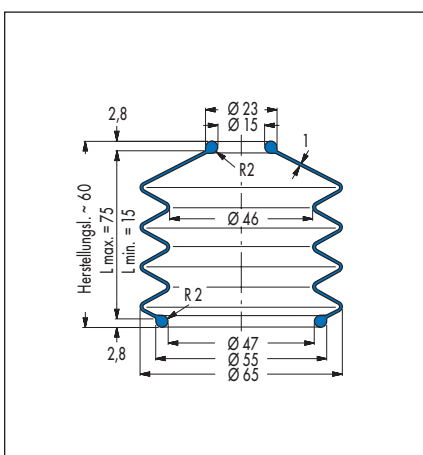

V6-00582, Artikel-Nr. 432918

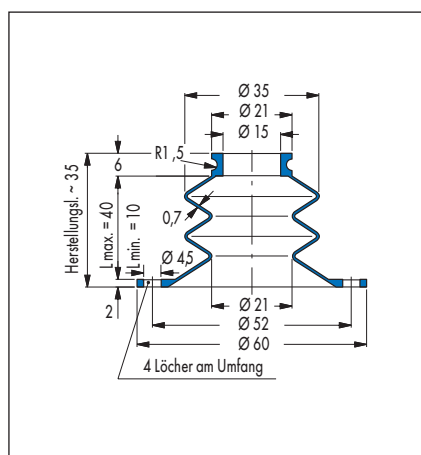

V6-00366, Artikel-Nr. 427266

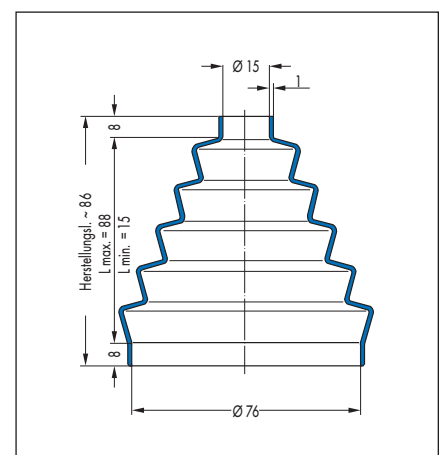

V6-00116, Artikel-Nr. 439182 (42 CR 764)/  
439181 (50 CR 879)

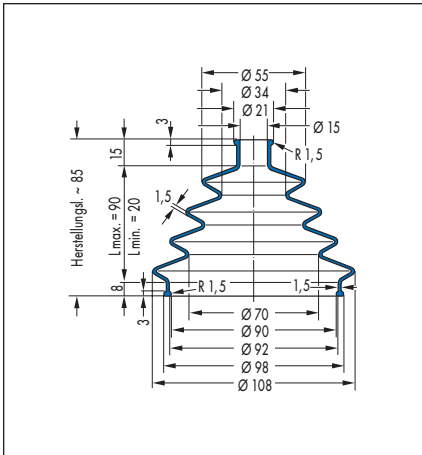

V6-00787, Artikel-Nr. 29962

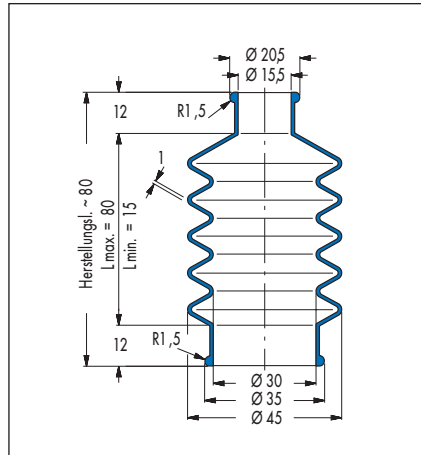

V6-01019, Artikel-Nr. 438569

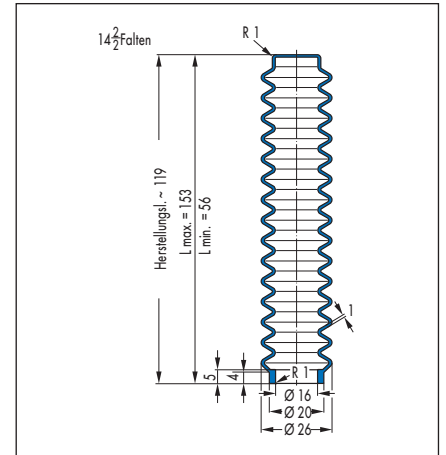

V6-01353, Artikel-Nr. 82687

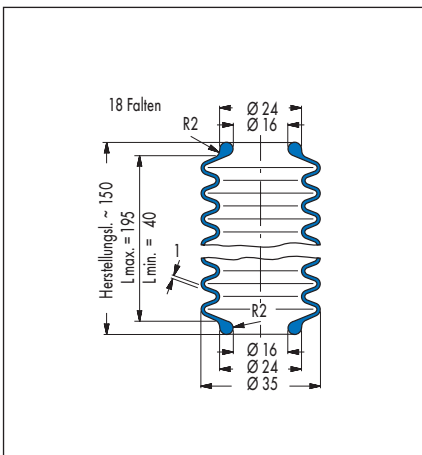

V6-00293, Artikel-Nr. 434026

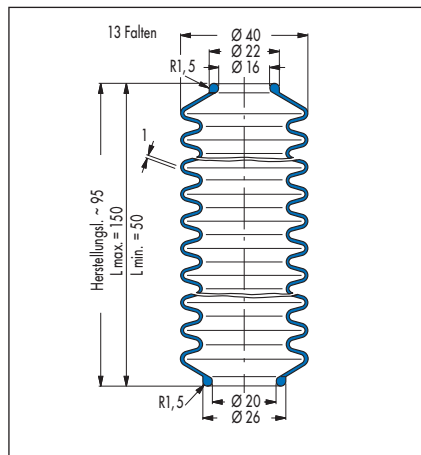

V6-00013, Artikel-Nr. 438211

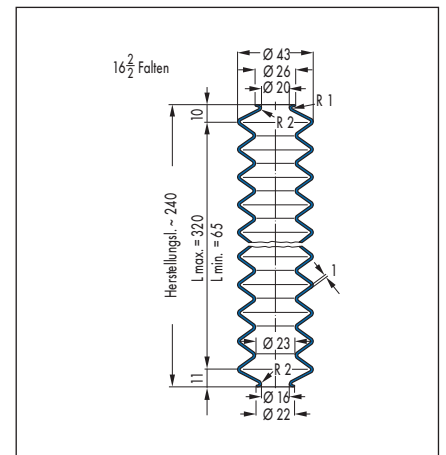

V6-00586, Artikel-Nr. 431276

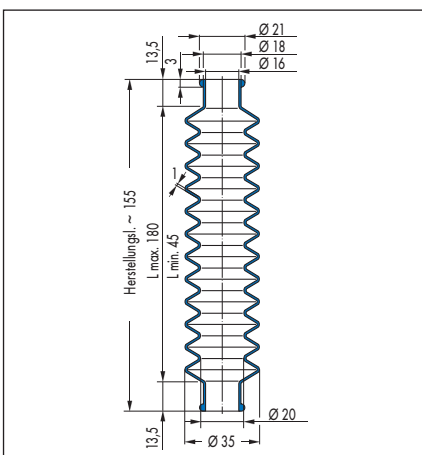

V6-00639, Artikel-Nr. 400785

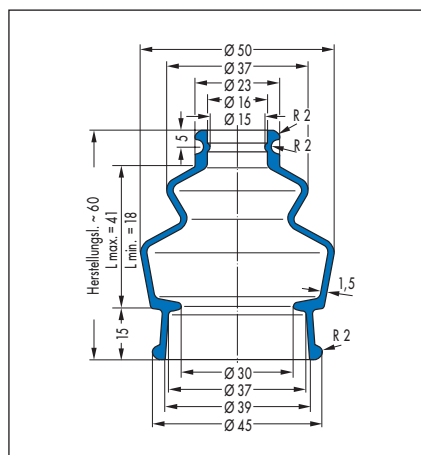

V6-00282, Artikel-Nr. 440305

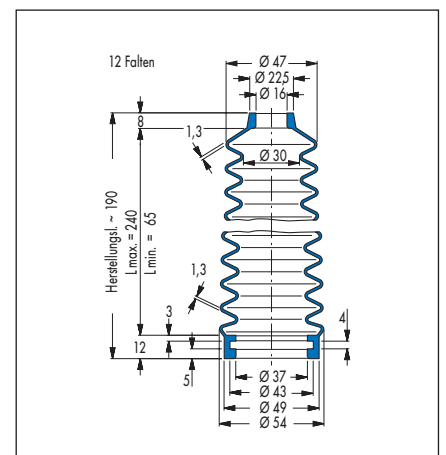

V6-00404, Artikel-Nr. 428849

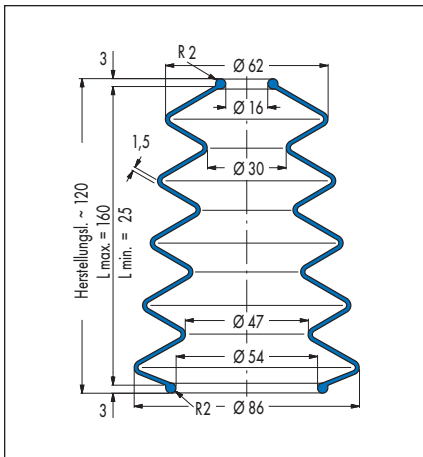

V6-00610, Artikel-Nr. 426375

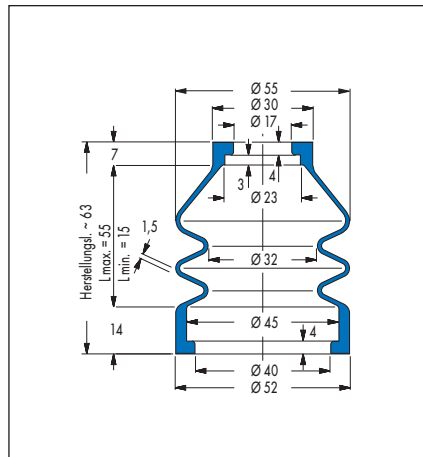

V6-00221, Artikel-Nr. 428830

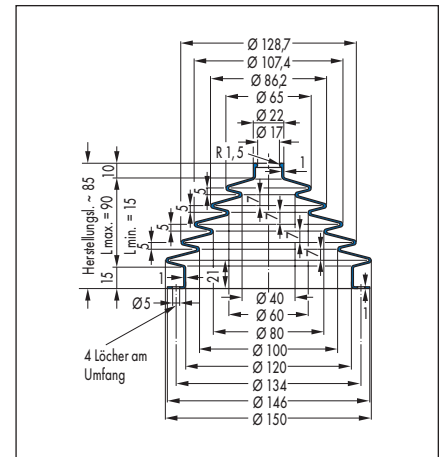

V6-01141, Artikel-Nr. 454243

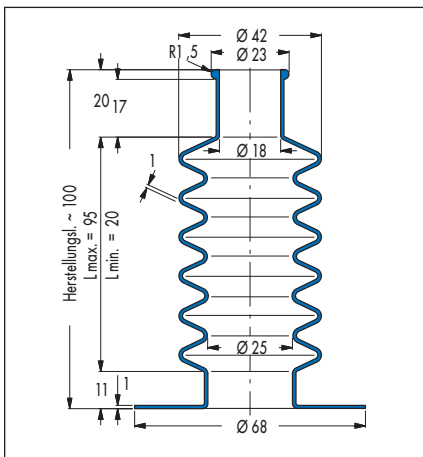

V6-00713, Artikel-Nr. 431525

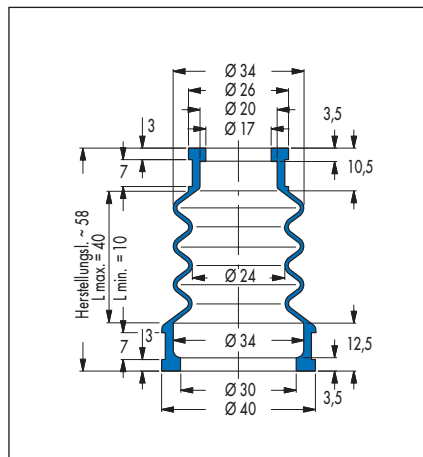

V6-00076, Artikel-Nr. 433980

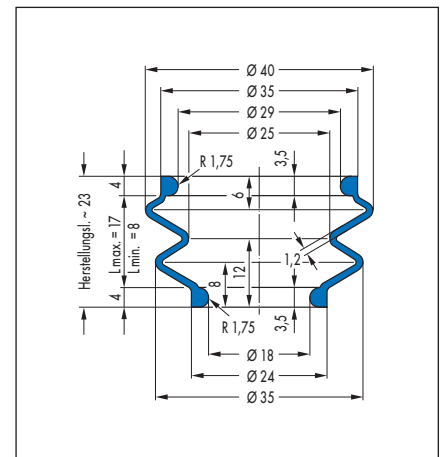

V6-01556, Artikel-Nr. 432591

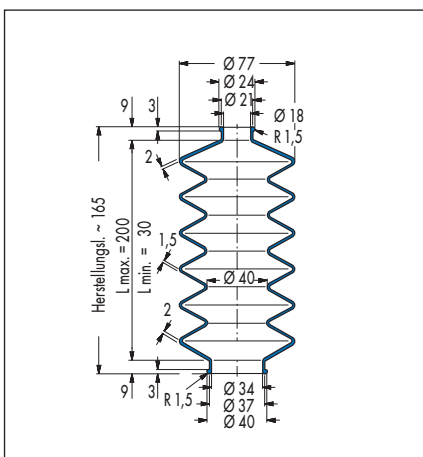

V6-00531, Artikel-Nr. 453728

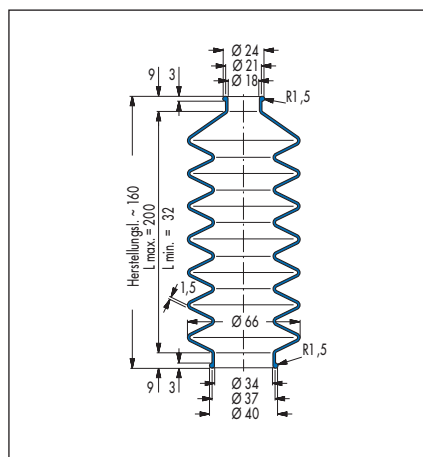

V6-00503, Artikel-Nr. 440392 (42 CR 764)/  
440391 (50 CR 879)

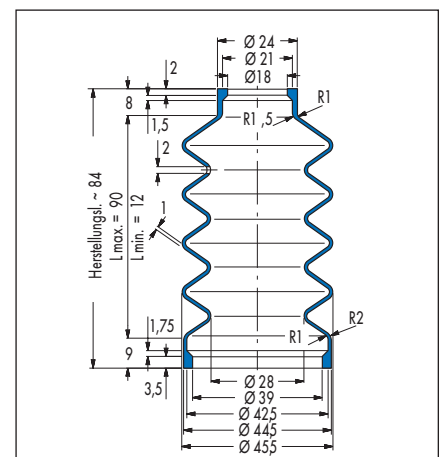

V6-00347, Artikel-Nr. 501252



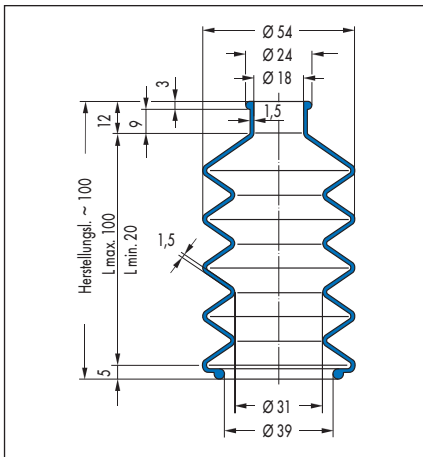

V6-00828, Artikel-Nr. 11520

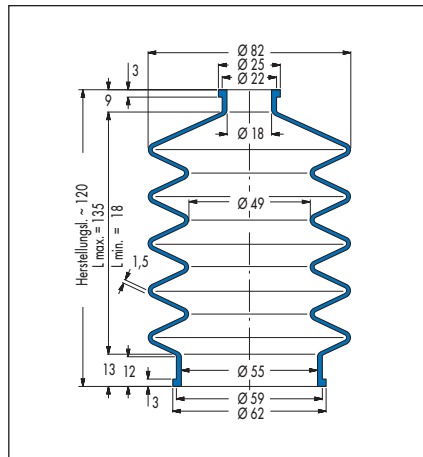

V6-00075, Artikel-Nr. 439195

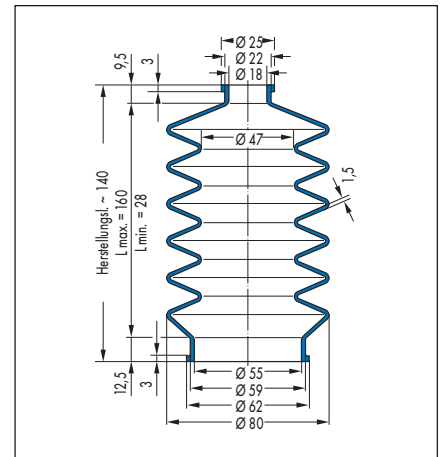

V6-00275, Artikel-Nr. 451293

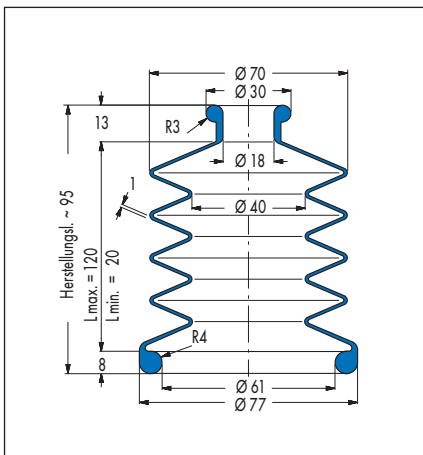

V6-00313, Artikel-Nr. 440315

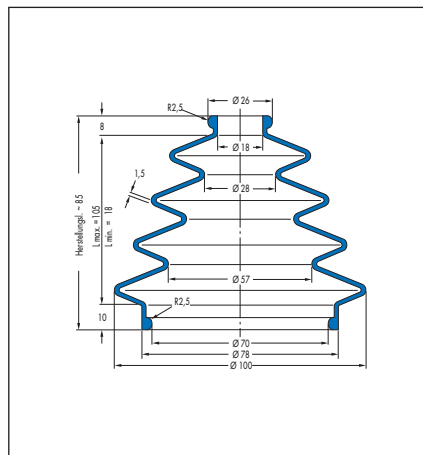

V6-00791, Artikel-Nr. 426798

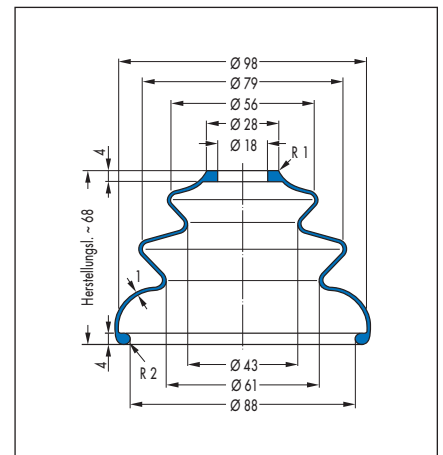

V6-00942, Artikel-Nr. 450411

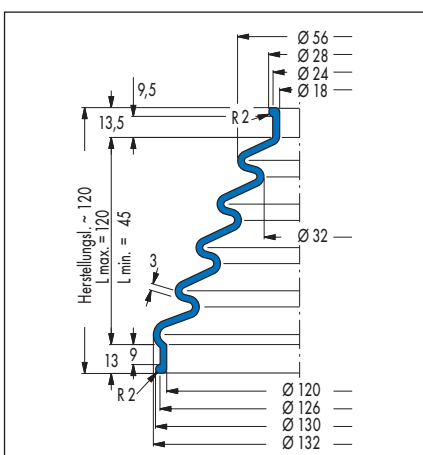

V6-00575, Artikel-Nr. 29752

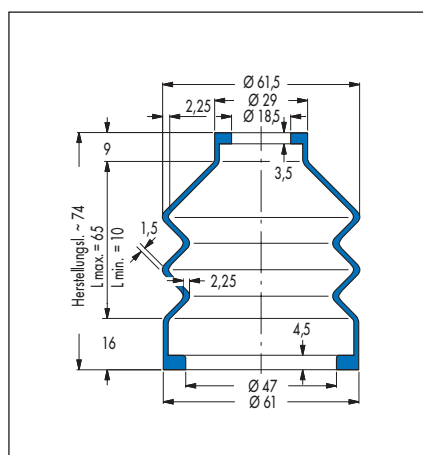

V6-00203, Artikel-Nr. 431289

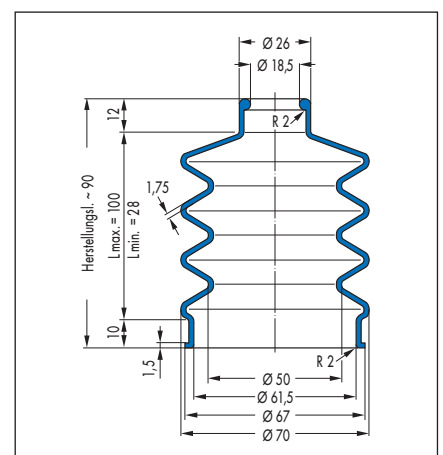

V6-00843, Artikel-Nr. 432191

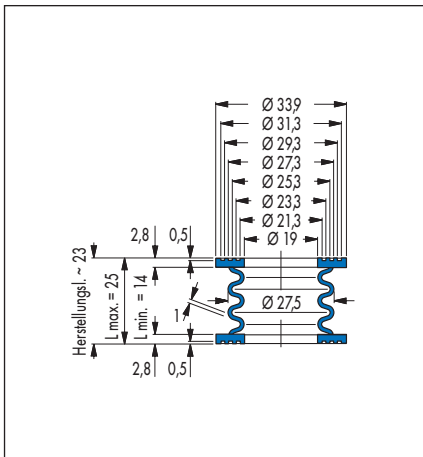

V6-00383, Artikel-Nr. 430846

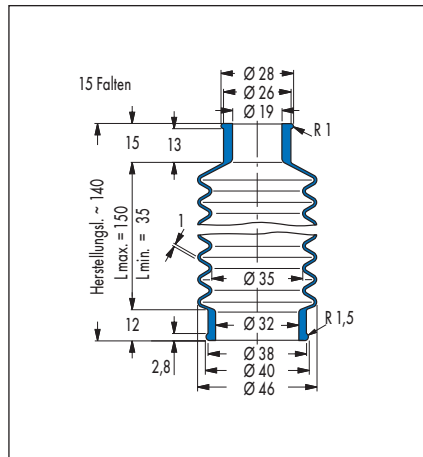

V6-00679, Artikel-Nr. 426799

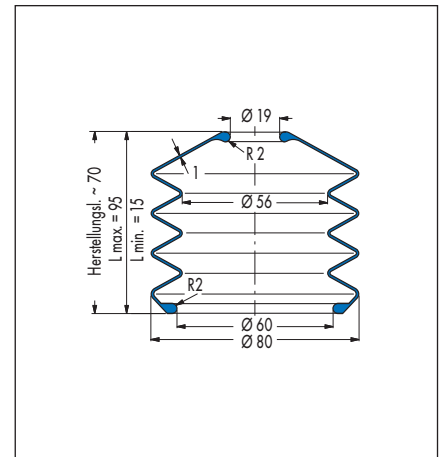

V6-00565, Artikel-Nr. 434030

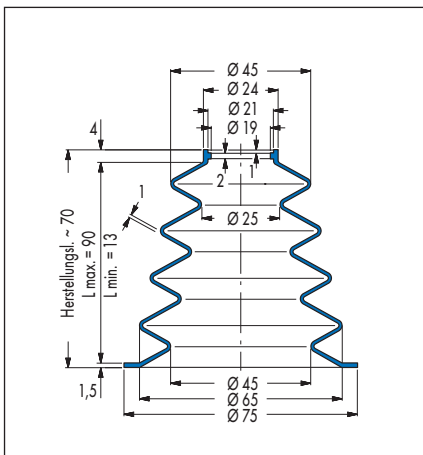

V6-00714, Artikel-Nr. 427269

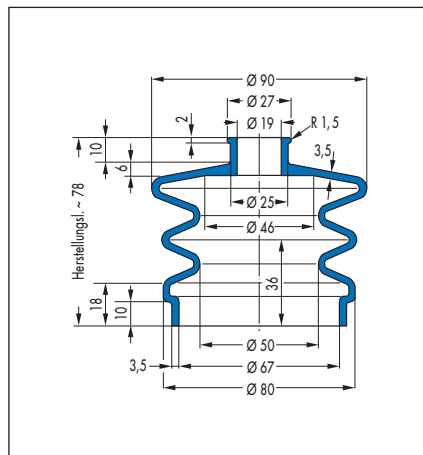

V6-20199, Artikel-Nr. 501112

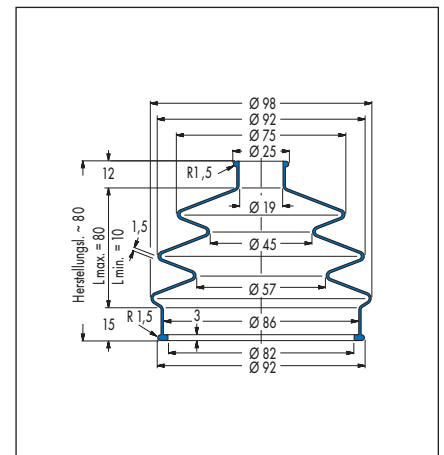

V6-00955, Artikel-Nr. 429670

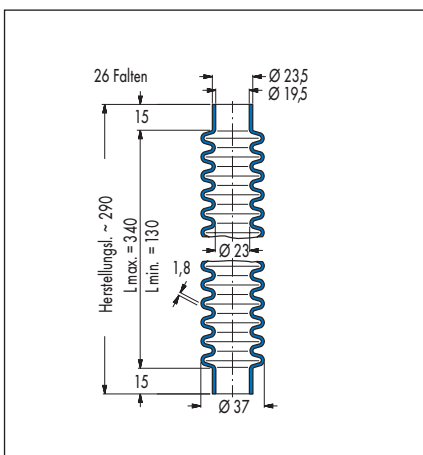

V6-00915, Artikel-Nr. 440260

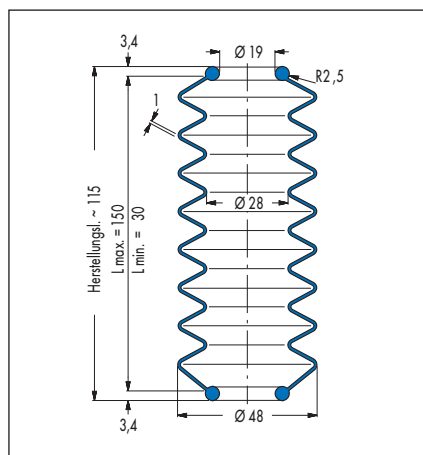

V6-00726, Artikel-Nr. 426387 (CR)/  
429078 (NBR)

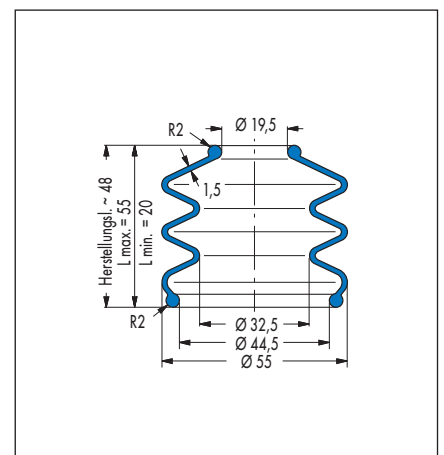

V6-00130, Artikel-Nr. 437298

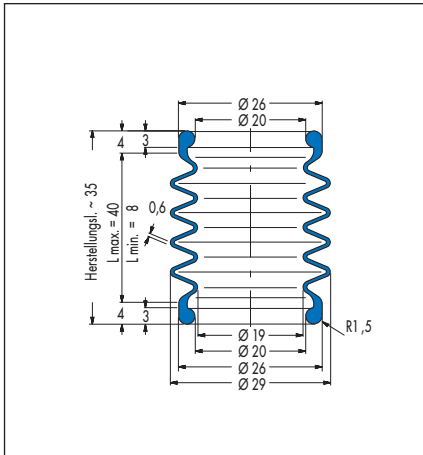

V6-00722, Artikel-Nr. 336382

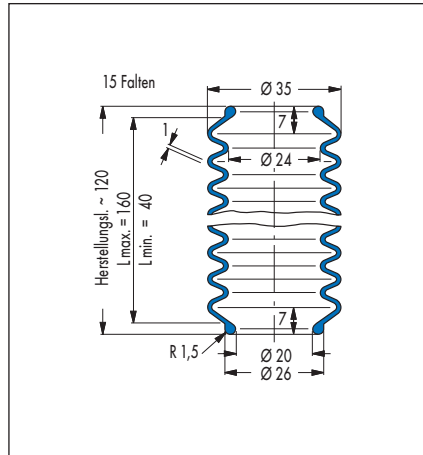

V6-00236, Artikel-Nr. 426319

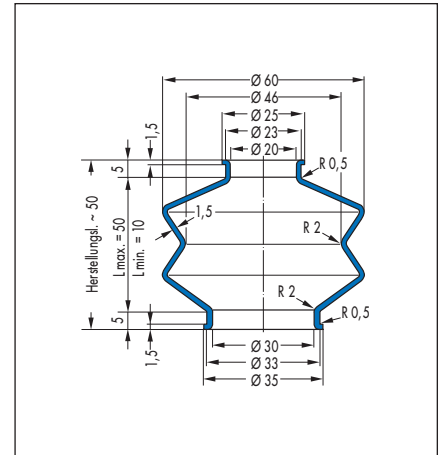

V6-00274, Artikel-Nr. 439432

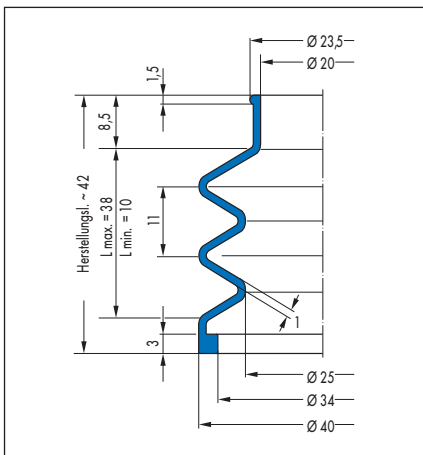

V6-01390, Artikel-Nr. 400988

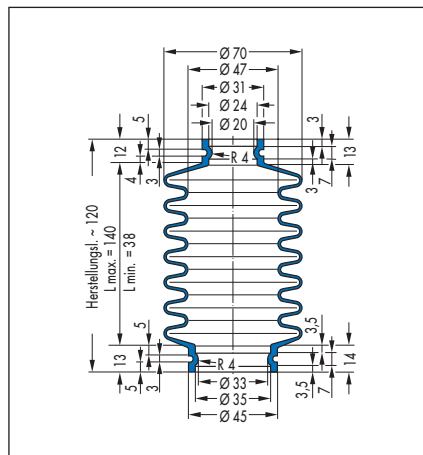

V6-00218, Artikel-Nr. 430858

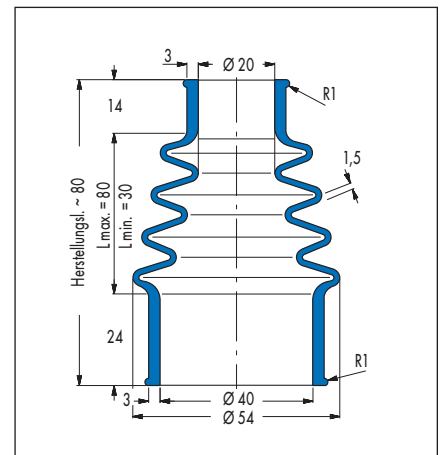

V6-01544, Artikel-Nr. 301805

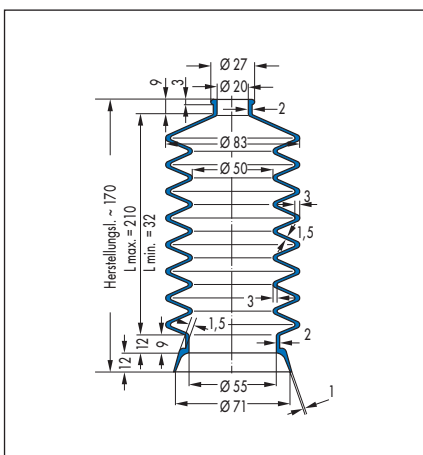

V6-00434, Artikel-Nr. 438213

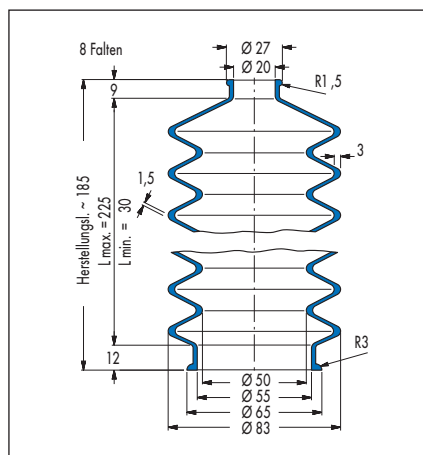

V6-00861, Artikel-Nr. 429667 (42 CR 764)/  
429668 (50 CR 879)

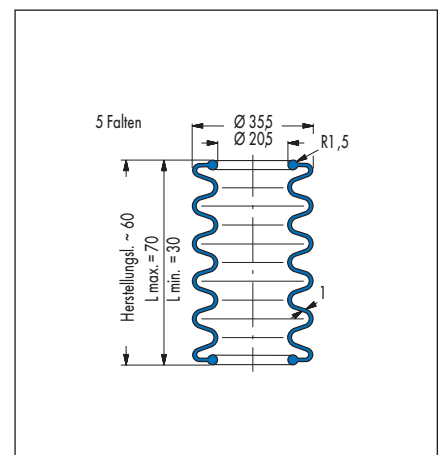

V6-00302, Artikel-Nr. 440318

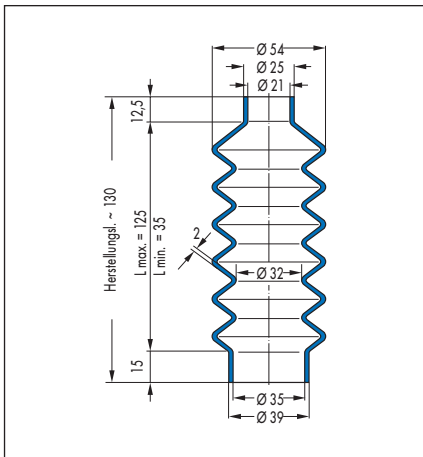

V6-00792, Artikel-Nr. 430861

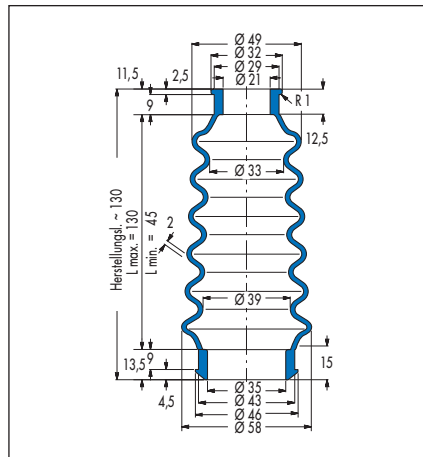

V6-00195, Artikel-Nr. 436916

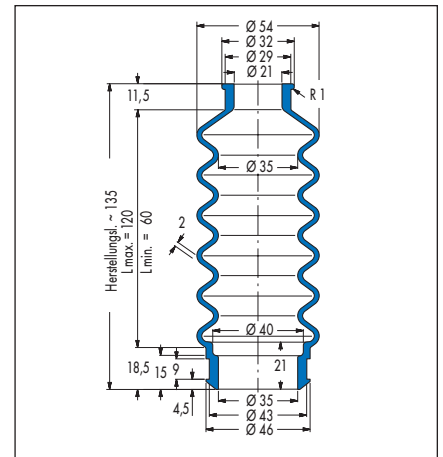

V6-00305, Artikel-Nr. 426323

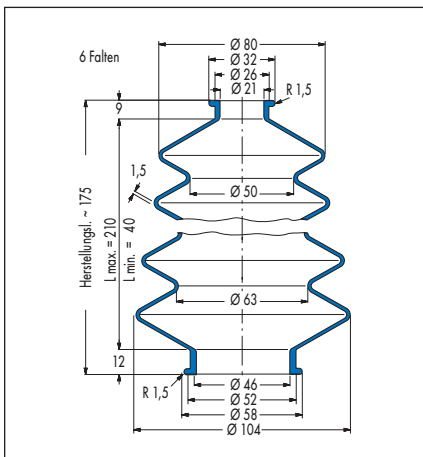

V6-00365, Artikel-Nr. 431649

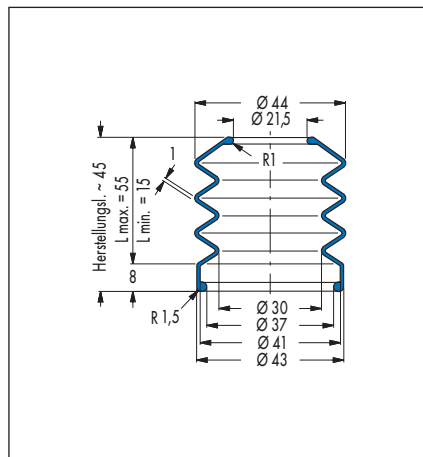

V6-00570, Artikel-Nr. 436744

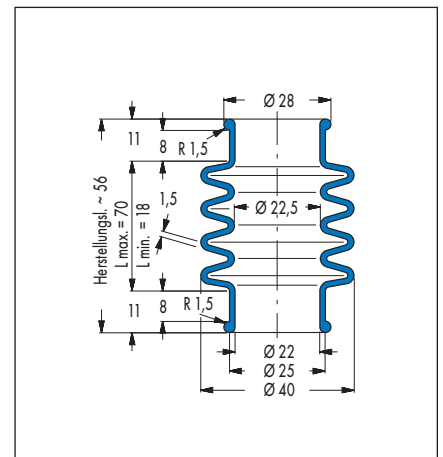

V6-00227, Artikel-Nr. 439167

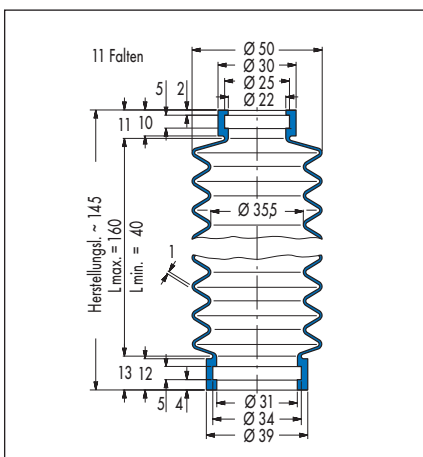

V6-00273, Artikel-Nr. 426370

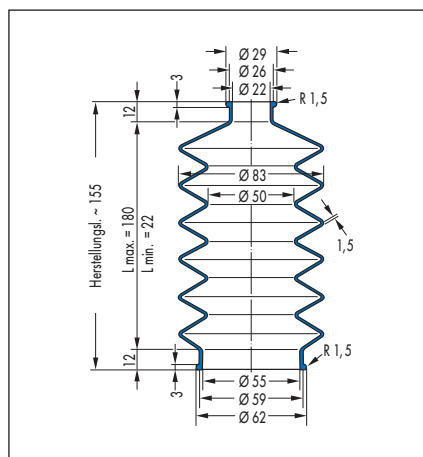

V6-00490, Artikel-Nr. 457774

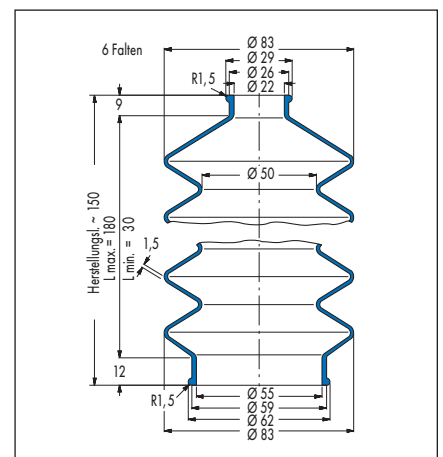

V6-00095, Artikel-Nr. 438519

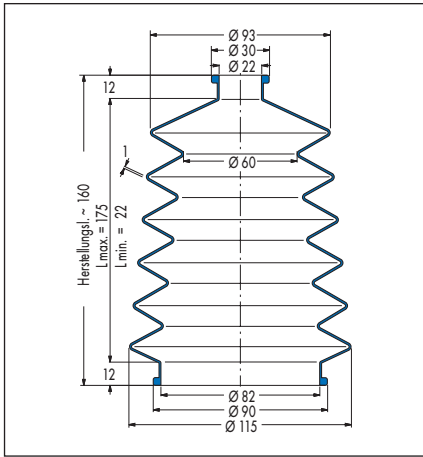

V6-00212, Artikel-Nr. 439178

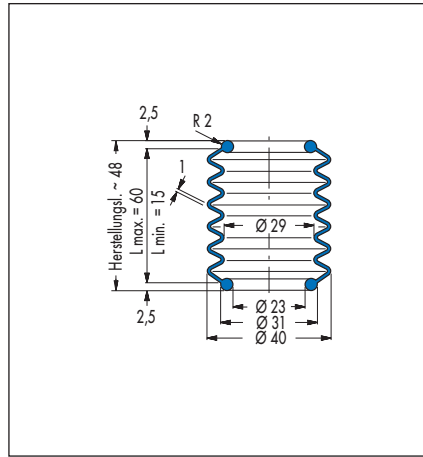

V6-00773, Artikel-Nr. 435481

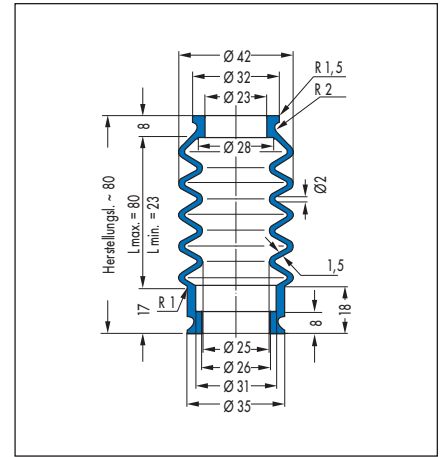

V6-00234, Artikel-Nr. 440348

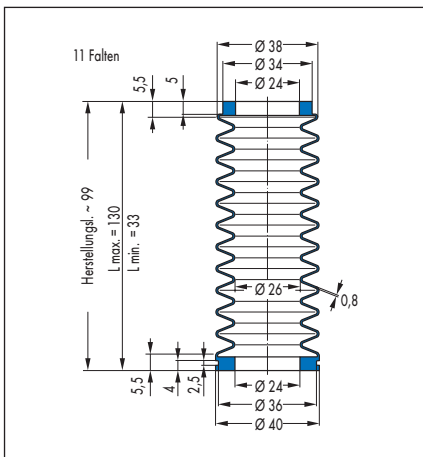

V6-20044, Artikel-Nr. 384441

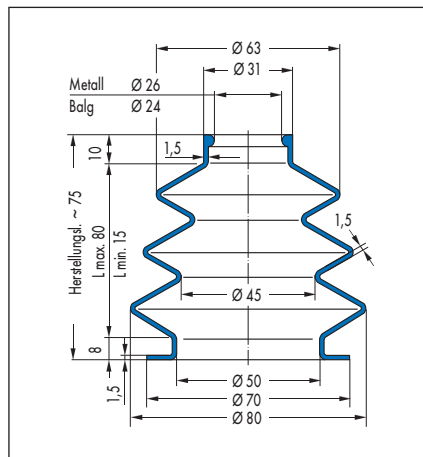

V6-00826, Artikel-Nr. 456489

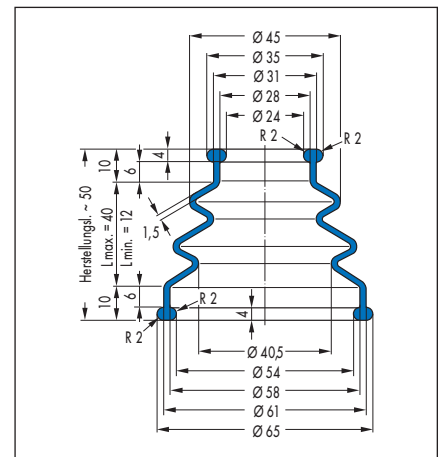

V6-00851, Artikel-Nr. 457841

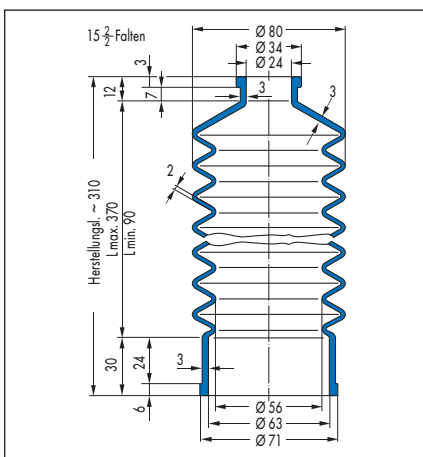

V6-00738, Artikel-Nr. 60037192

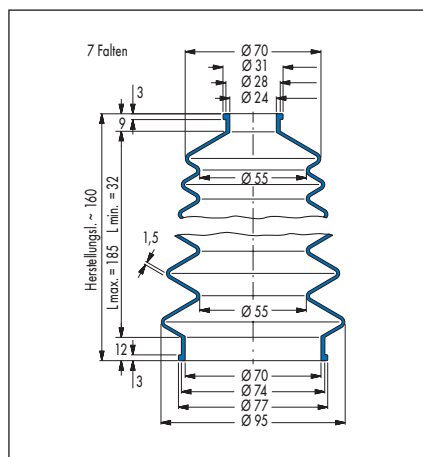

V6-00069, Artikel-Nr. 432599 [42 CR 764]/  
432600 [53 CR 858]

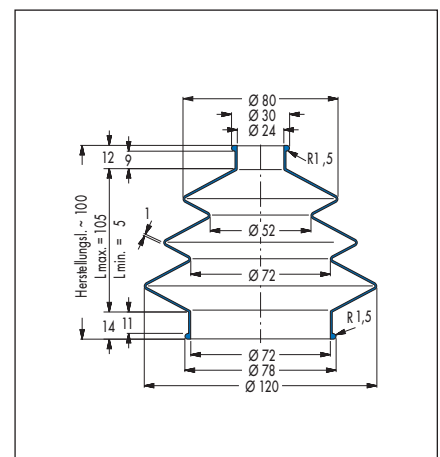

V6-00604, Artikel-Nr. 436936

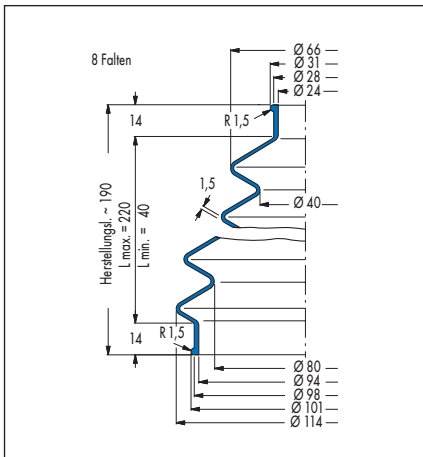

V6-00530, Artikel-Nr. 427267

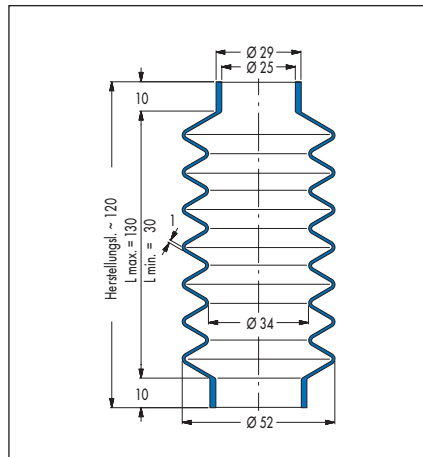

V6-00416, Artikel-Nr. 434015

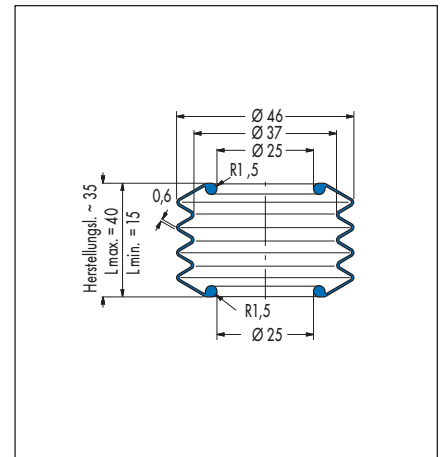

V6-00462, Artikel-Nr. 440279 (CR)/  
440283 (NBR)

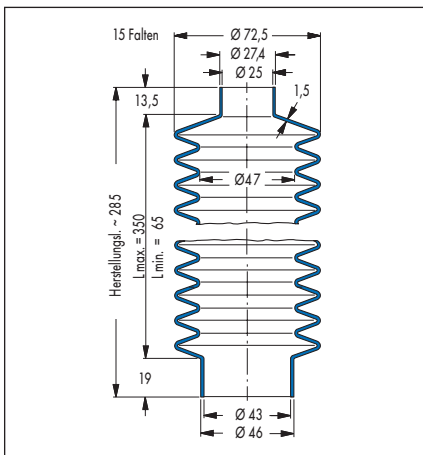

V6-00059, Artikel-Nr. 29213

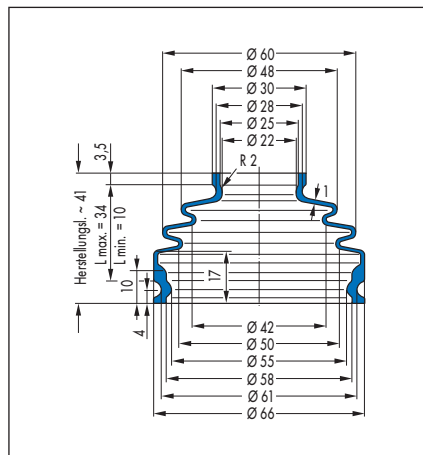

V6-00997, Artikel-Nr. 451314

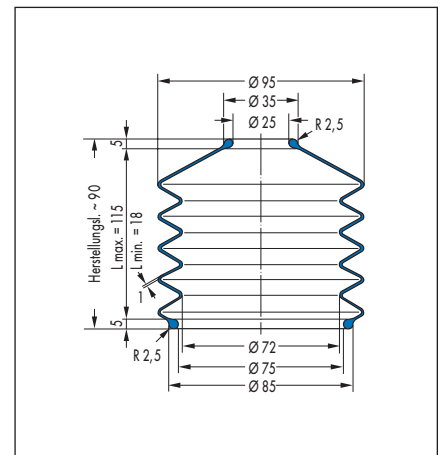

V6-00583, Artikel-Nr. 457502

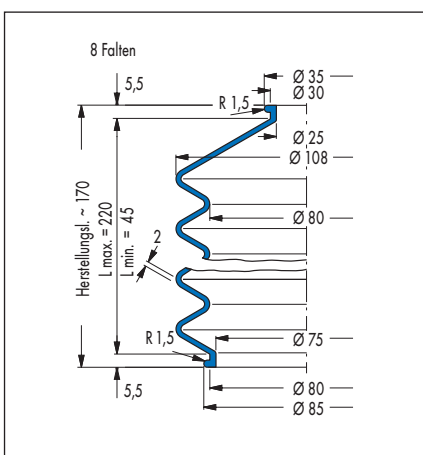

V6-00251, Artikel-Nr. 435518

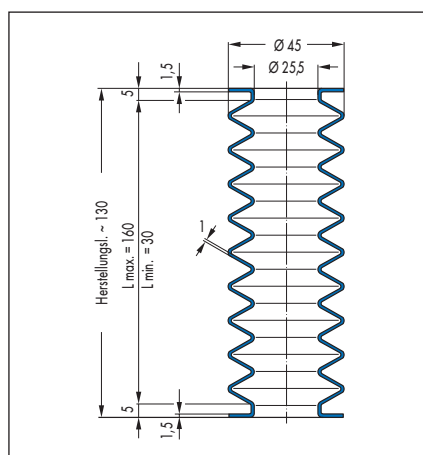

V6-00966, Artikel-Nr. 350974

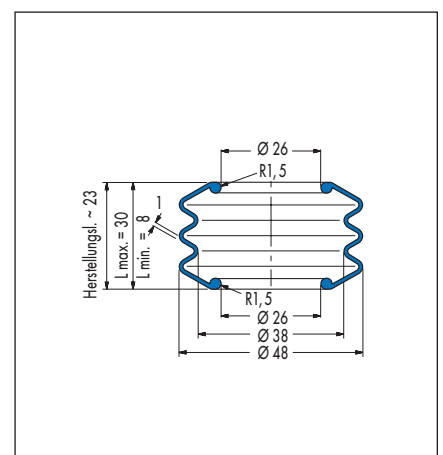

V6-00127, Artikel-Nr. 432585

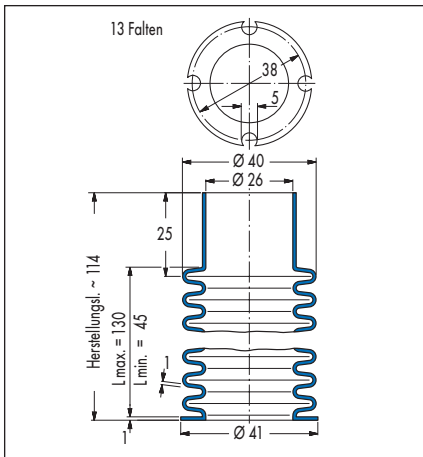

V6-00200, Artikel-Nr. 438022

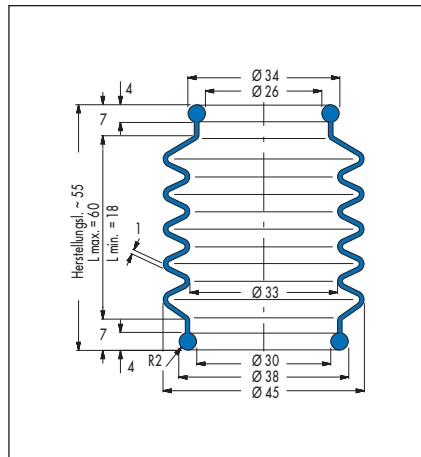

V6-00592, Artikel-Nr. 426382

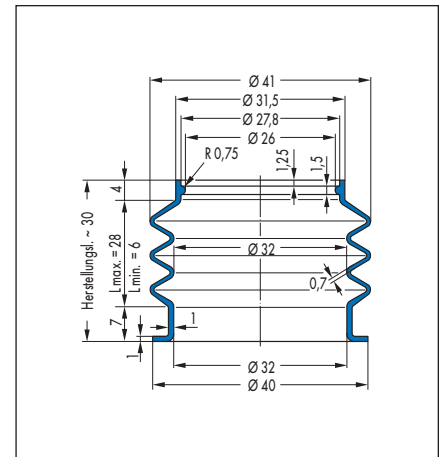

V6-00835, Artikel-Nr. 452564

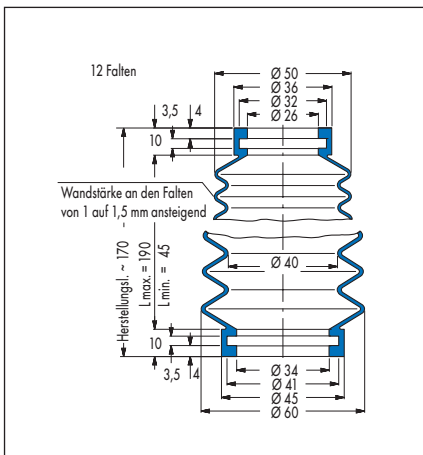

V6-00292, Artikel-Nr. 436699

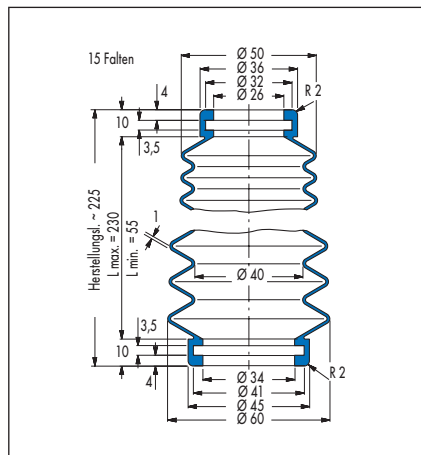

V6-00401, Artikel-Nr. 440291

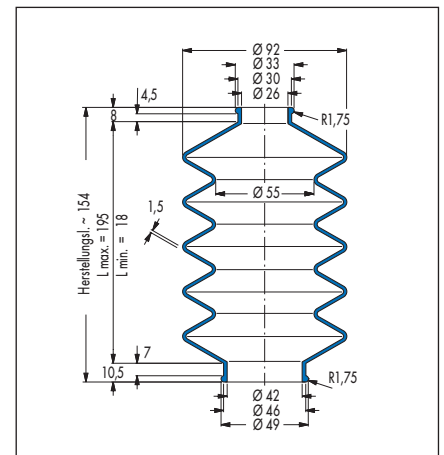

V6-00079, Artikel-Nr. 431867

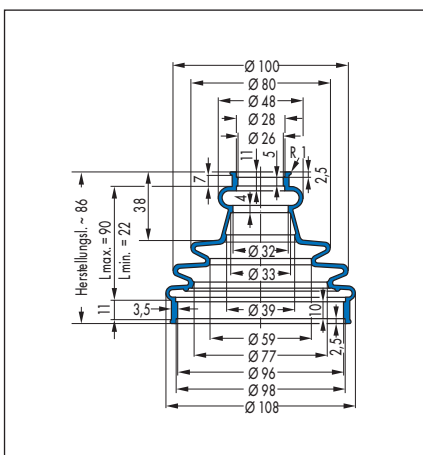

V6-01755, Artikel-Nr. 451384

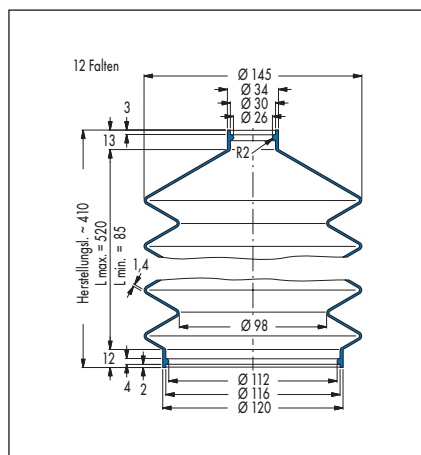

V6-01156, Artikel-Nr. 454245

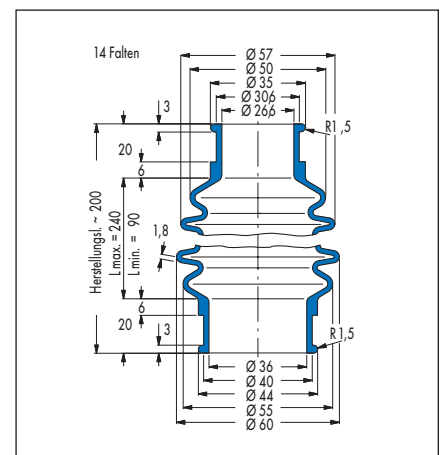

V6-00324, Artikel-Nr. 440316

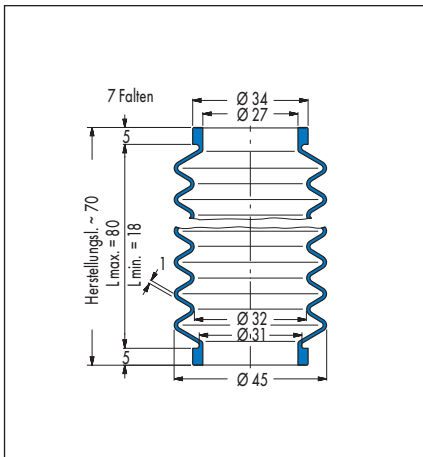

V6-00290, Artikel-Nr. 432590

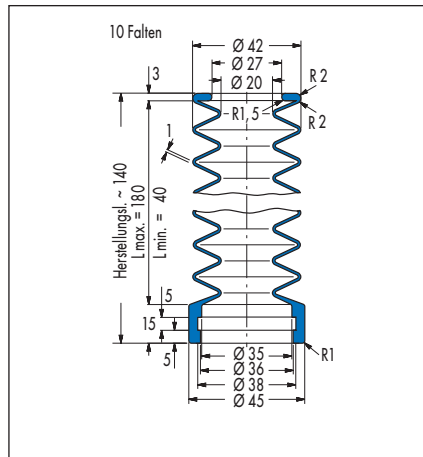

V6-00259, Artikel-Nr. 439441

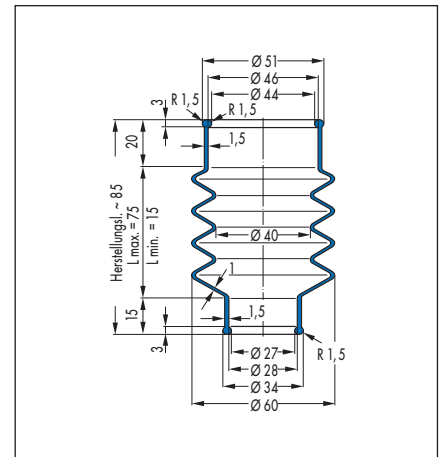

V6-00363, Artikel-Nr. 432594

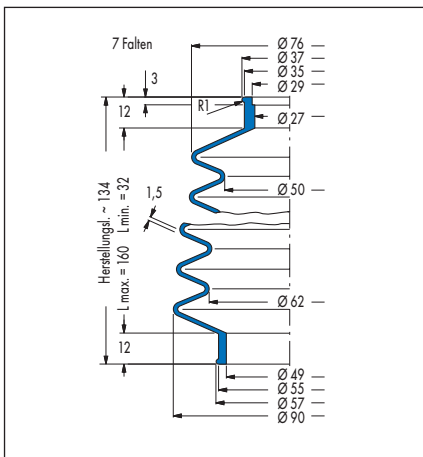

V6-00106, Artikel-Nr. 430856 (NBR)/  
430857 (CR)

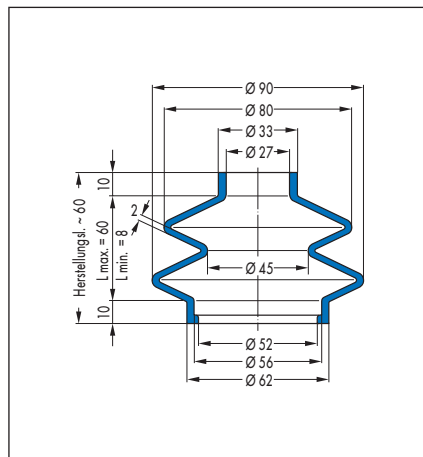

V6-01055, Artikel-Nr. 457773

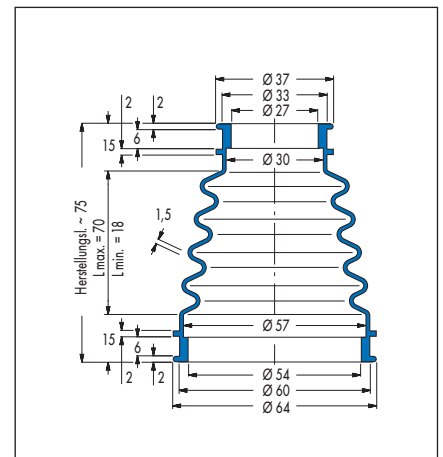

V6-00857, Artikel-Nr. 434023

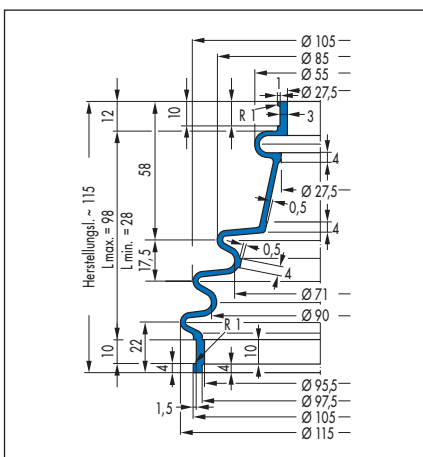

V6-01723, Artikel-Nr. 438571

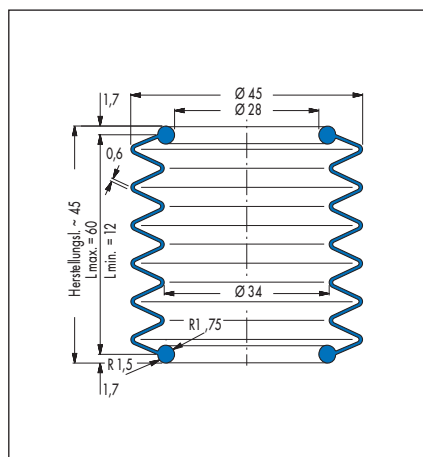

V6-00640, Artikel-Nr. 427268

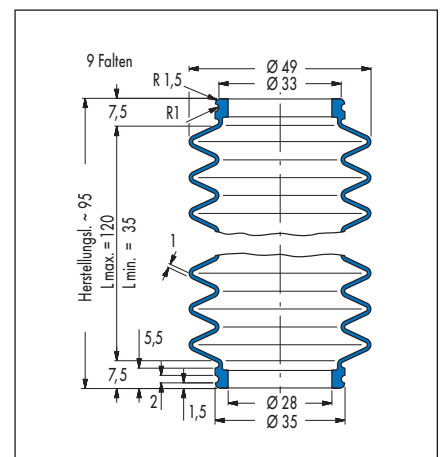

V6-00296, Artikel-Nr. 426795



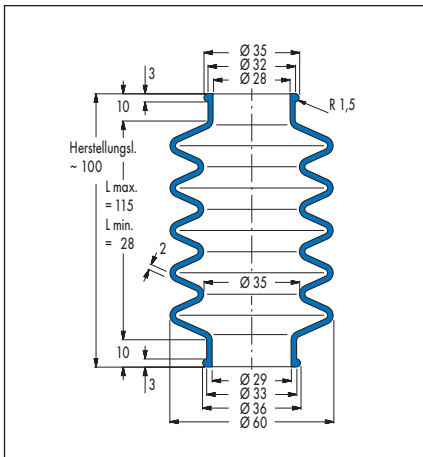

V6-00594, Artikel-Nr. 429662

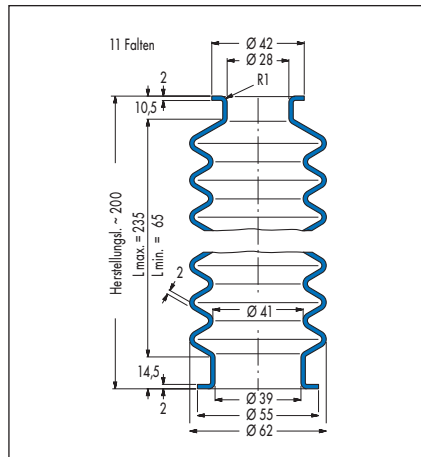

V6-00755, Artikel-Nr. 451312

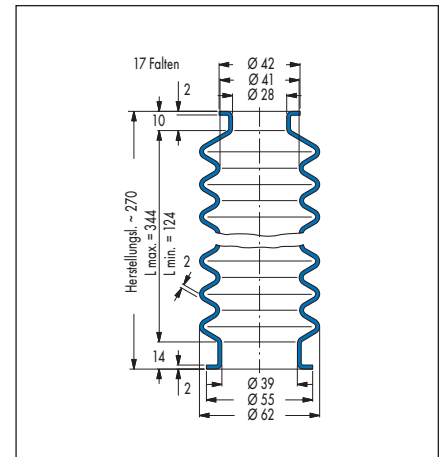

V6-00201, Artikel-Nr. 454462

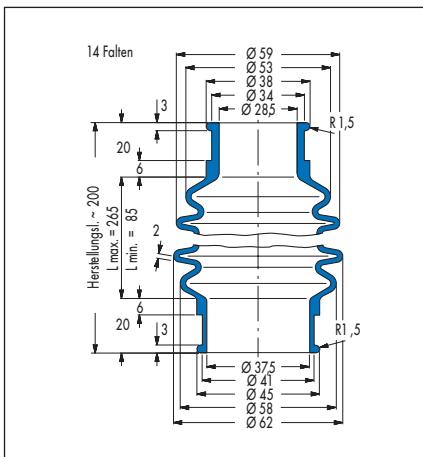

V6-00325, Artikel-Nr. 426794

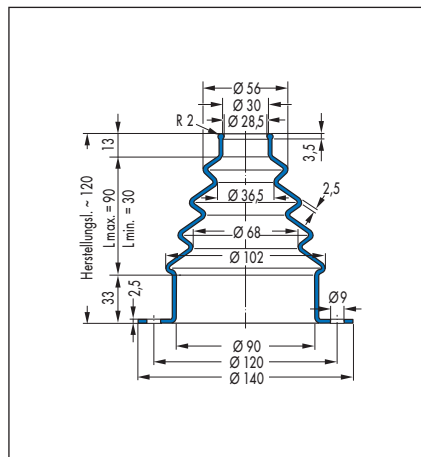

V6-00475, Artikel-Nr. 400708

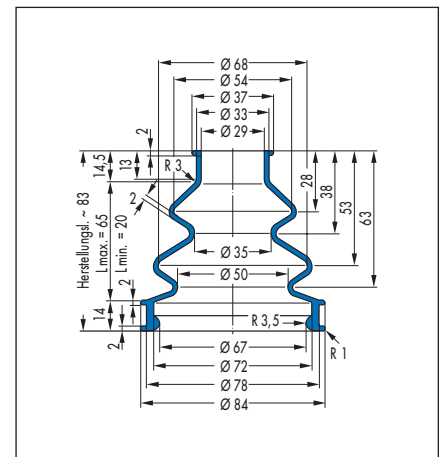

V6-01023, Artikel-Nr. 454488

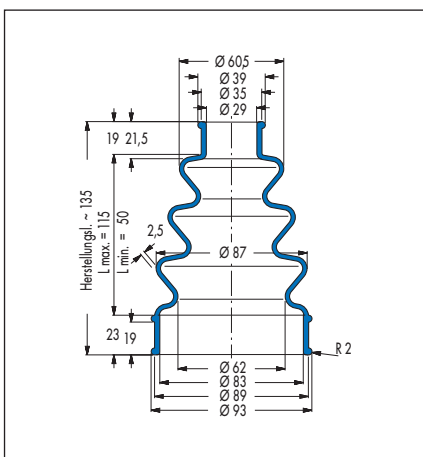

V6-00384, Artikel-Nr. 440317

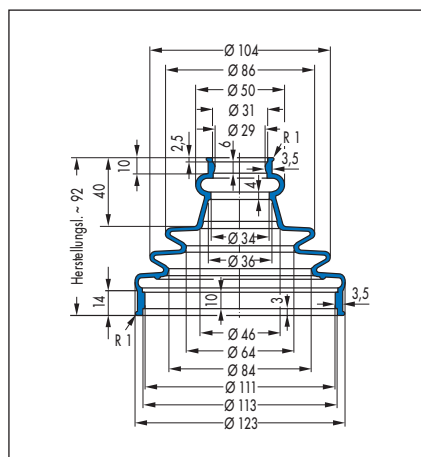

V6-01754, Artikel-Nr. 451337

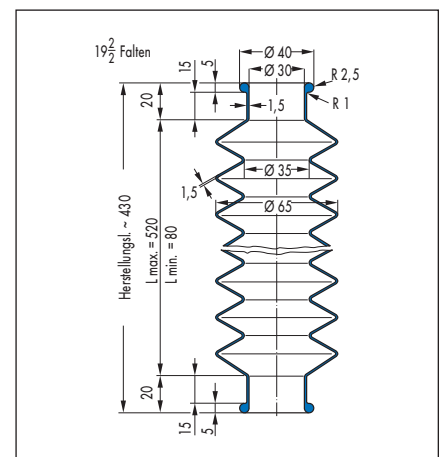

V6-00589, Artikel-Nr. 15267

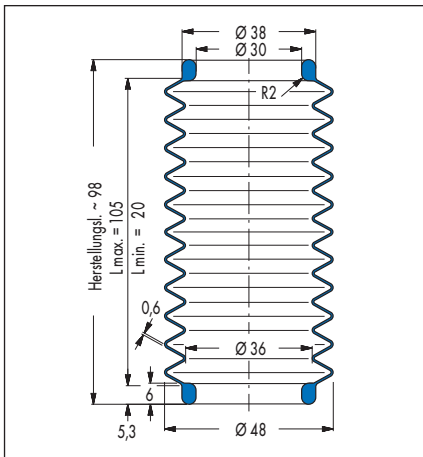

V6-00904, Artikel-Nr. 375419

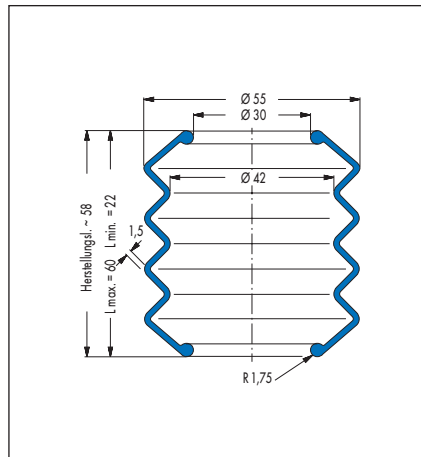

V6-00422, Artikel-Nr. 428310

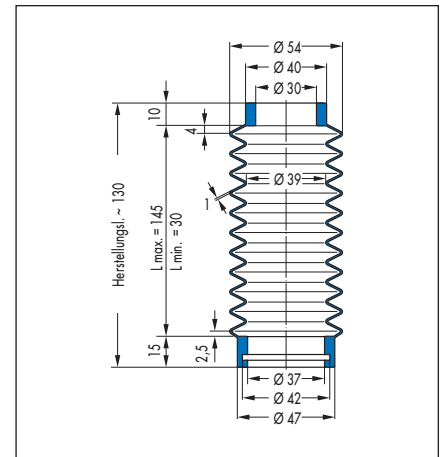

V6-00824, Artikel-Nr. 368141

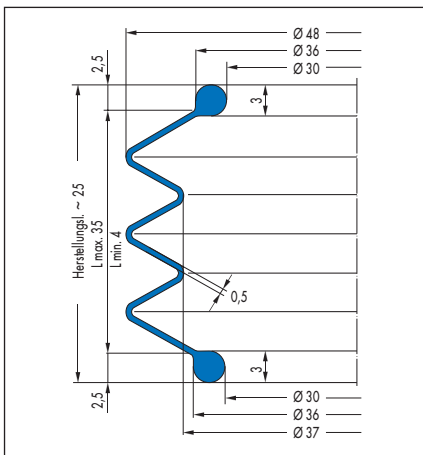

V6-00720, Artikel-Nr. 400804

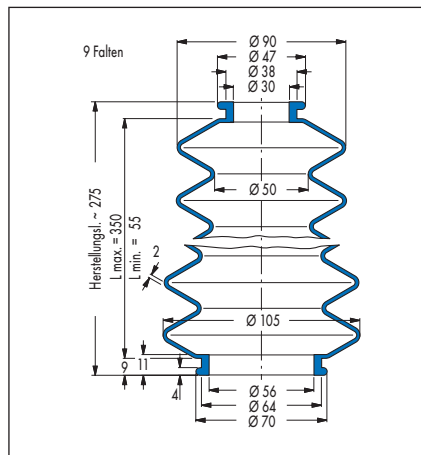

V6-00456, Artikel-Nr. 29663

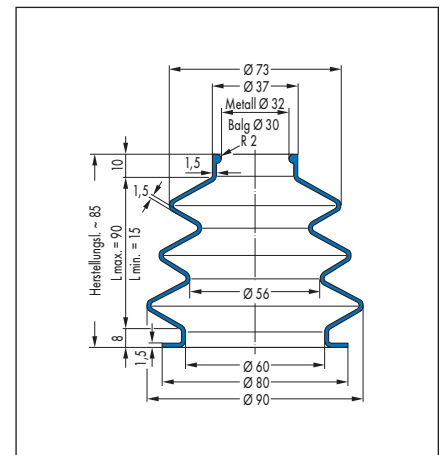

V6-00805, Artikel-Nr. 365839

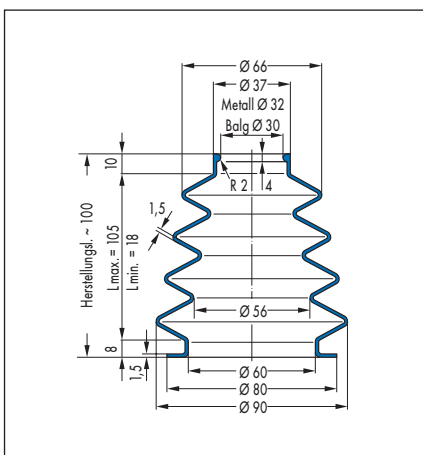

V6-00827, Artikel-Nr. 355702

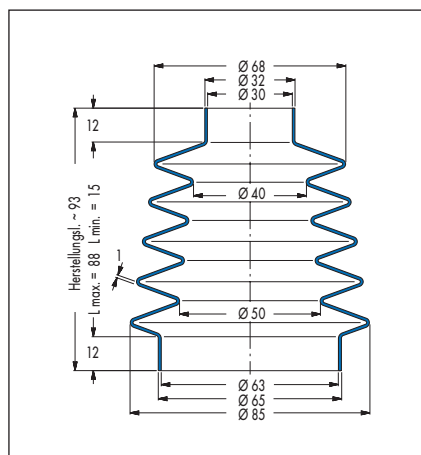

V6-01329, Artikel-Nr. 60305

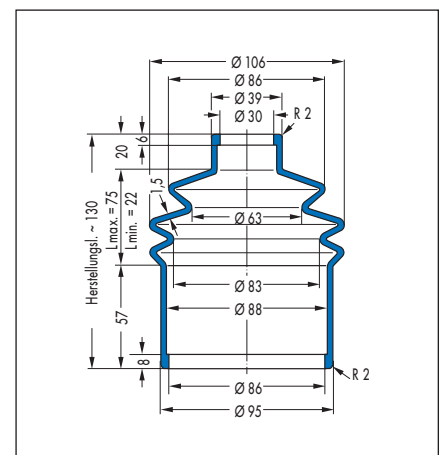

V6-00314, Artikel-Nr. 451741

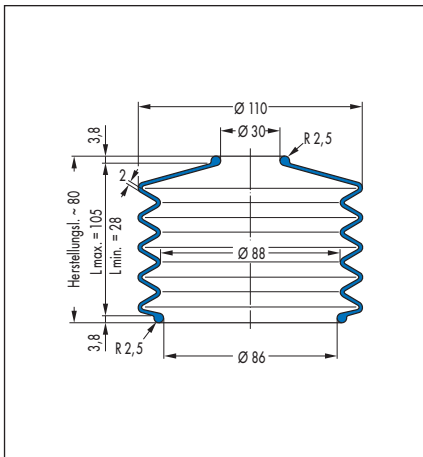

V6-00903, Artikel-Nr. 438936

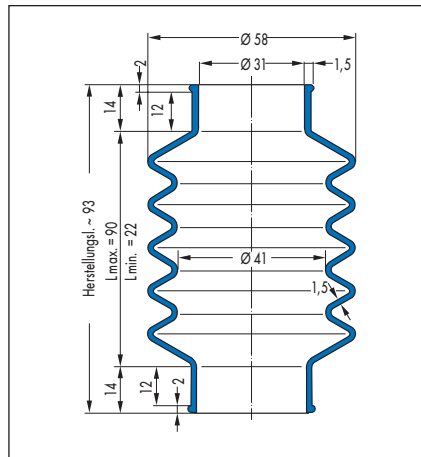

V6-00448, Artikel-Nr. 122870 (50 CR 879)/  
49046170 (60 CR 176307)

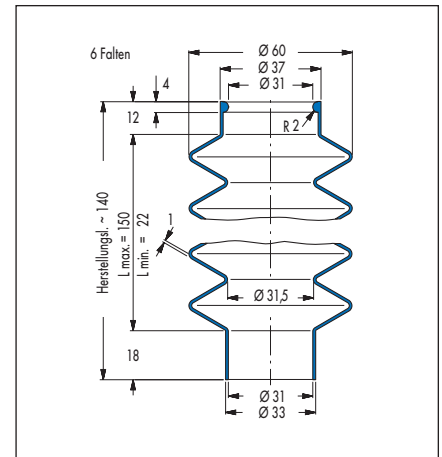

V6-00603, Artikel-Nr. 438548

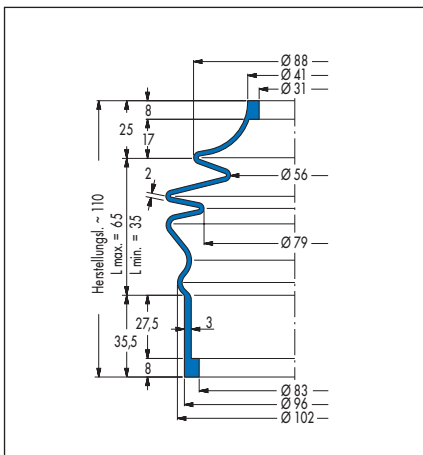

V6-00206, Artikel-Nr. 428315

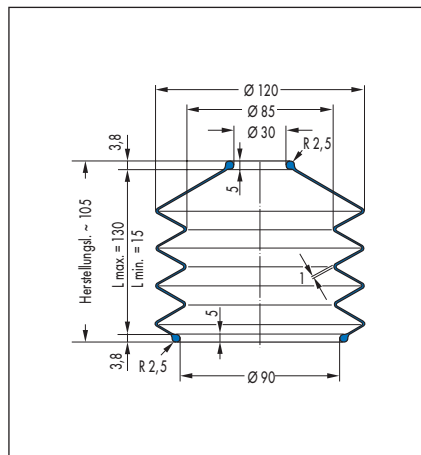

V6-00584, Artikel-Nr. 375144

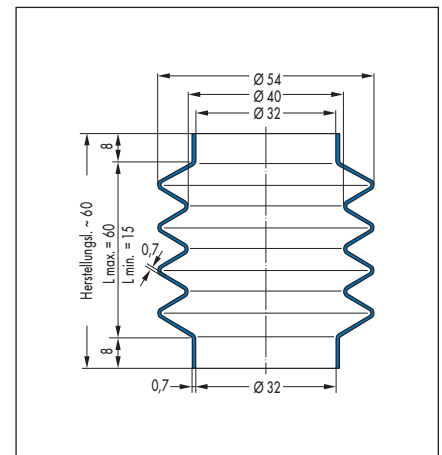

V6-01236, Artikel-Nr. 436913

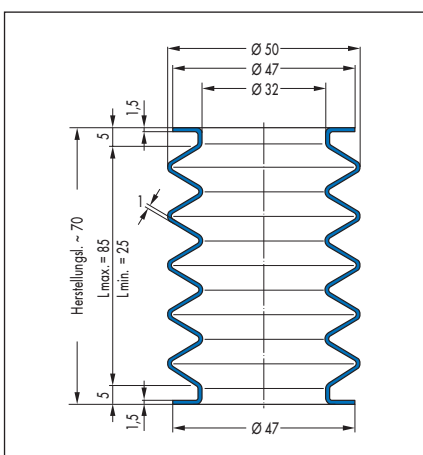

V6-00965, Artikel-Nr. 453784

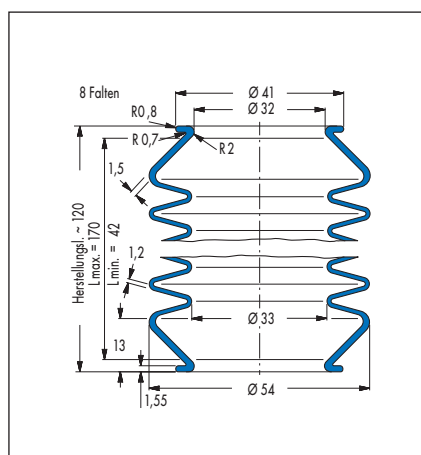

V6-00209, Artikel-Nr. 439186

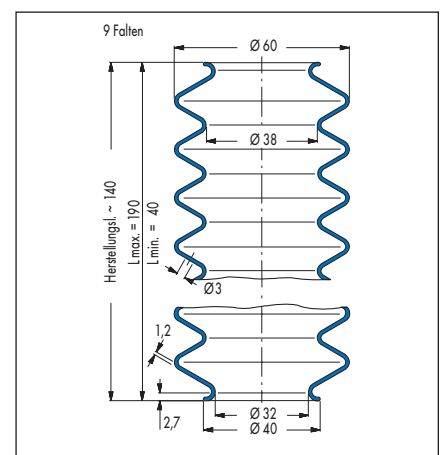

V6-00407, Artikel-Nr. 428832

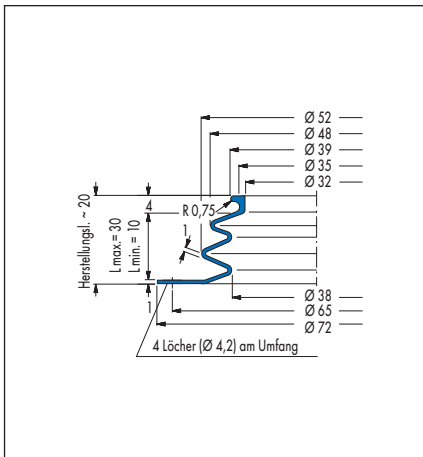

V6-00736, Artikel-Nr. 426374

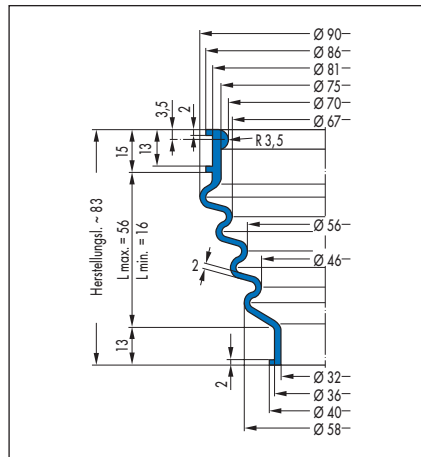

V6-01431, Artikel-Nr. 454267

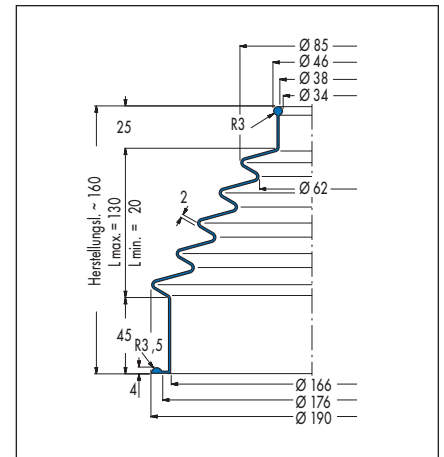

V6-00925, Artikel-Nr. 454474

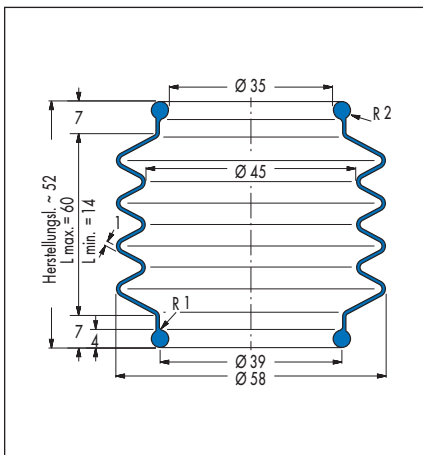

V6-00659, Artikel-Nr. 424147

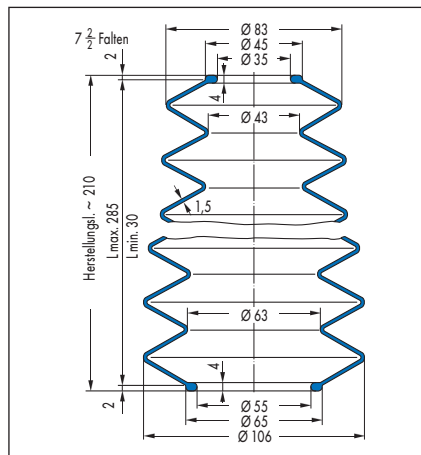

V6-00652, Artikel-Nr. 457563

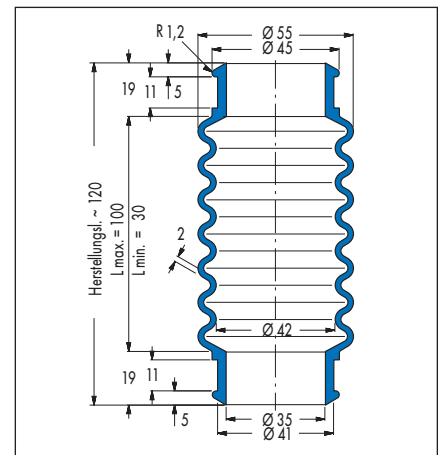

V6-00281, Artikel-Nr. 427264

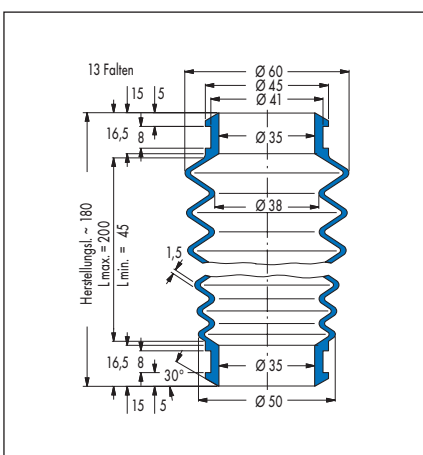

V6-00266, Artikel-Nr. 429647

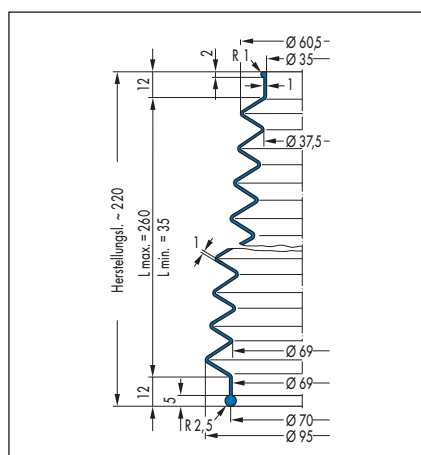

V6-01080, Artikel-Nr. 457509

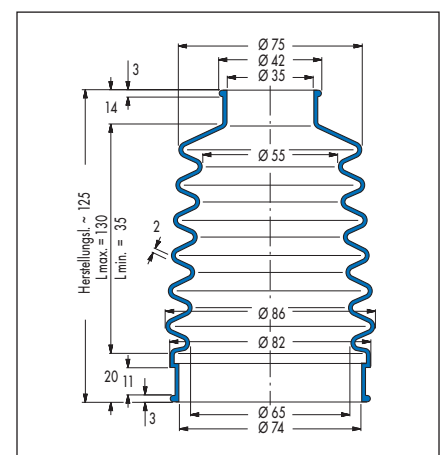

V6-00654, Artikel-Nr. 434029

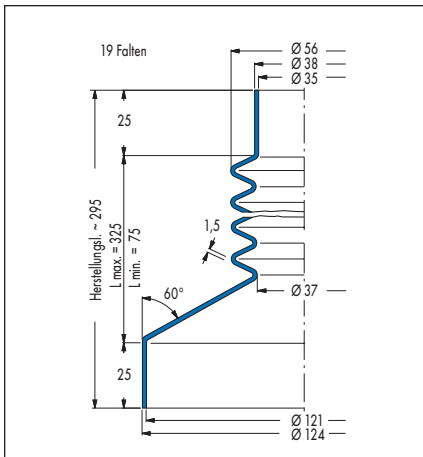

V6-00117, Artikel-Nr. 29288

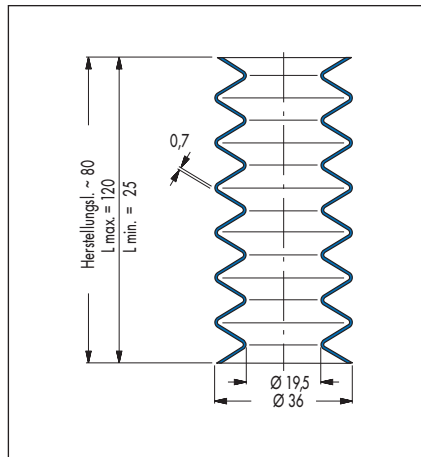

V6-00053, Artikel-Nr. 435517

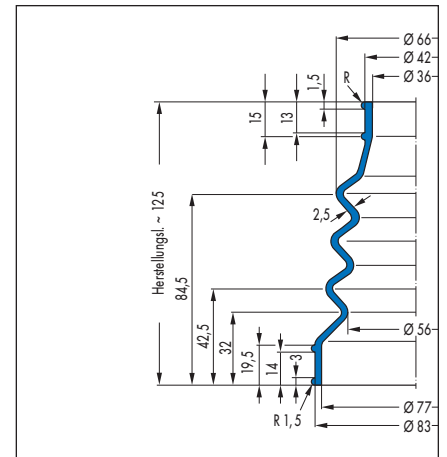

V6-01449, Artikel-Nr. 152544

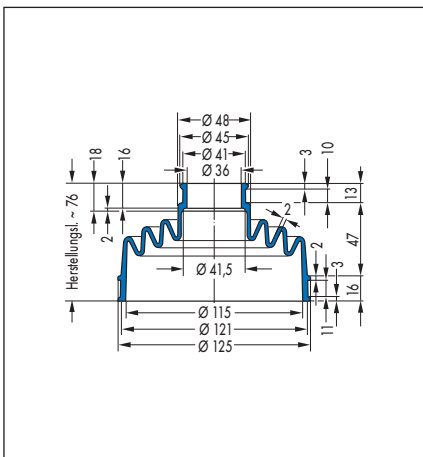

V6-00419, Artikel-Nr. 507686

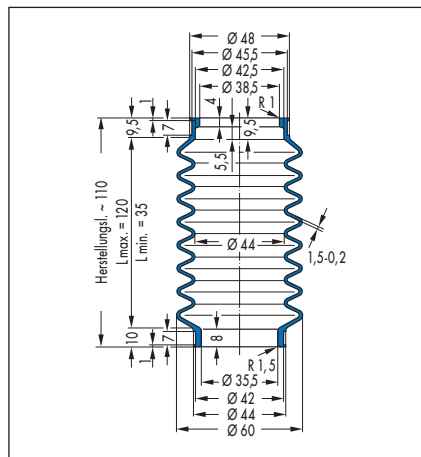

V6-00204, Artikel-Nr. 439168

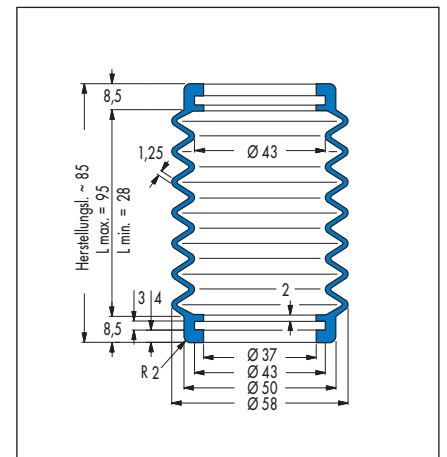

V6-00308, Artikel-Nr. 427265

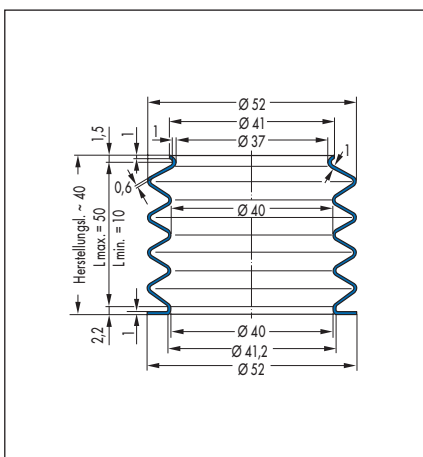

V6-00467, Artikel-Nr. 456485

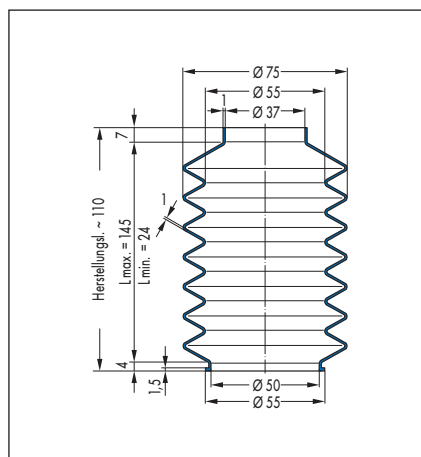

V6-00790, Artikel-Nr. 29965

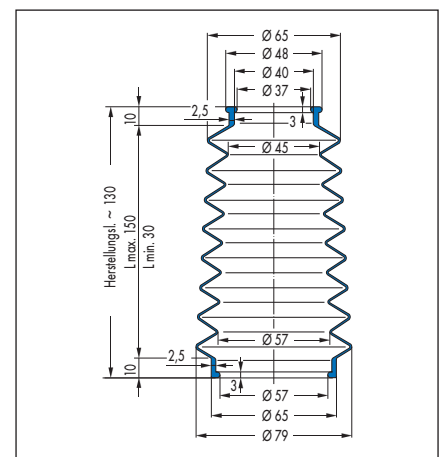

V6-00823, Artikel-Nr. 400862

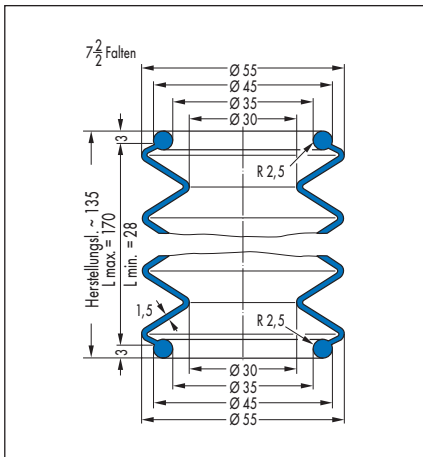

V6-00297, Artikel-Nr. 501137

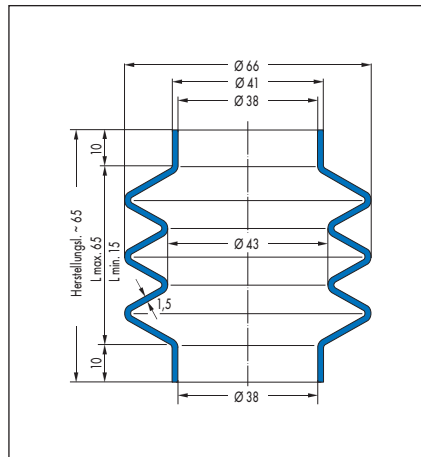

V6-00808, Artikel-Nr. 439042

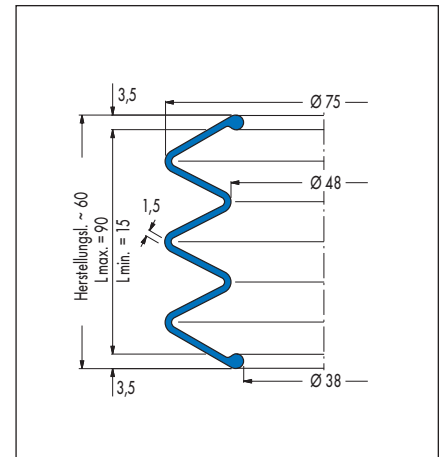

V6-00429, Artikel-Nr. 431588

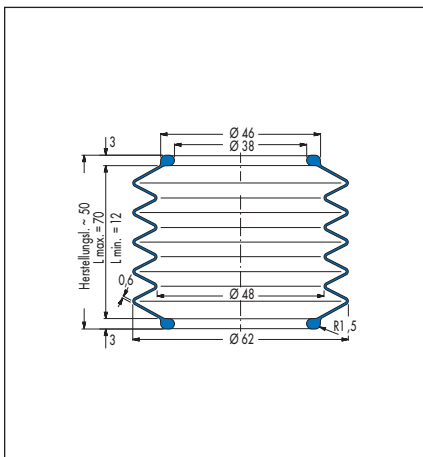

V6-00662, Artikel-Nr. 434077

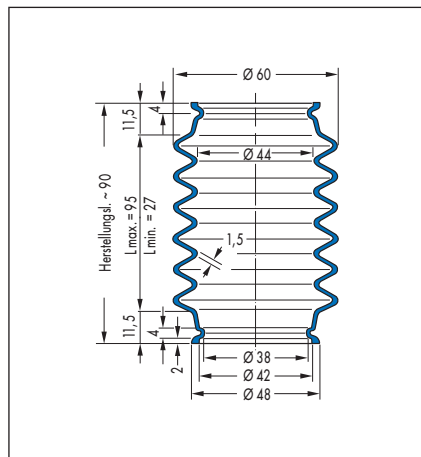

V6-00255, Artikel-Nr. 451751

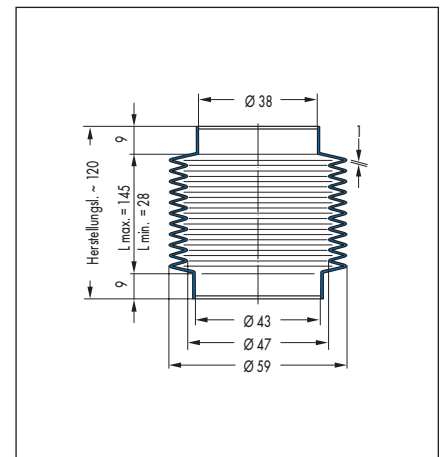

V6-00230, Artikel-Nr. 439434

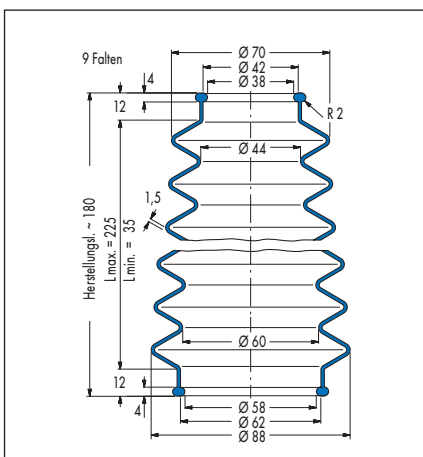

V6-00619, Artikel-Nr. 431955

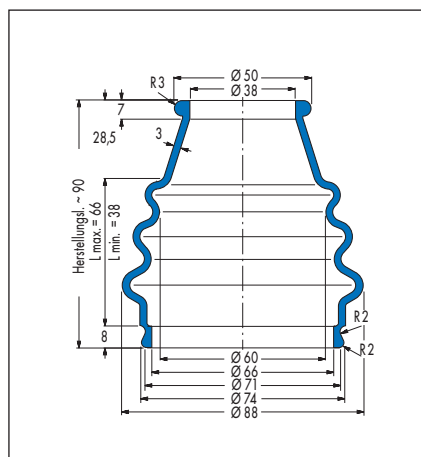

V6-00190, Artikel-Nr. 438014

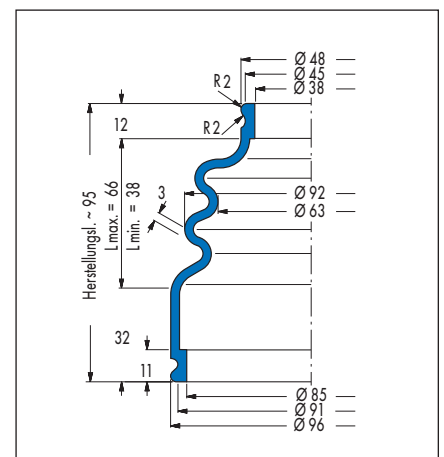

V6-00191, Artikel-Nr. 428311

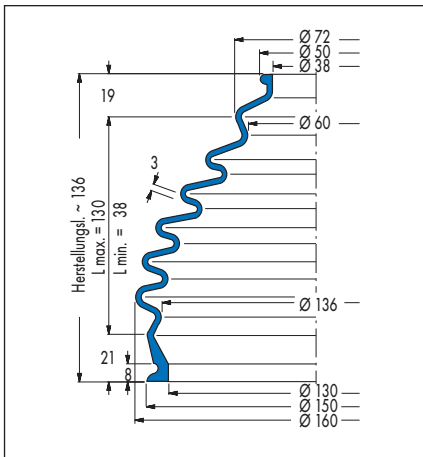

V6-00199, Artikel-Nr. 438027

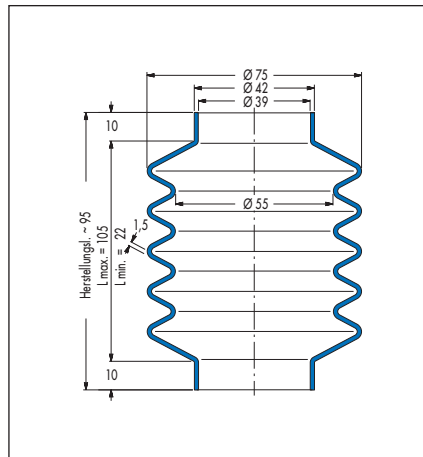

V6-00321, Artikel-Nr. 429648

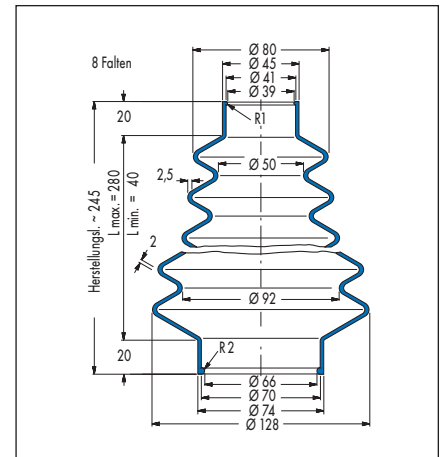

V6-00556, Artikel-Nr. 29735

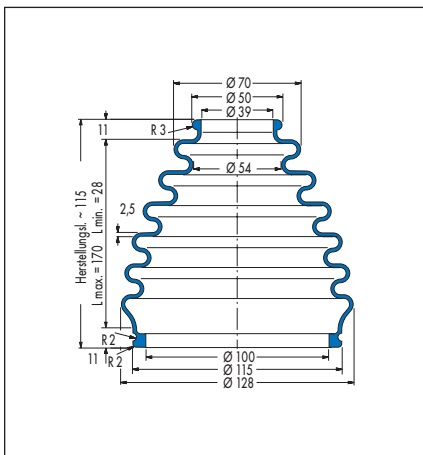

V6-00060, Artikel-Nr. 428322

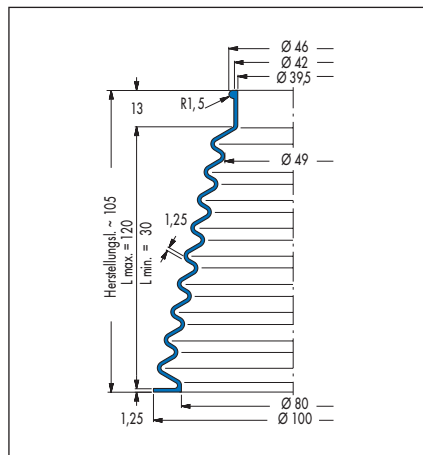

V6-00188, Artikel-Nr. 432643

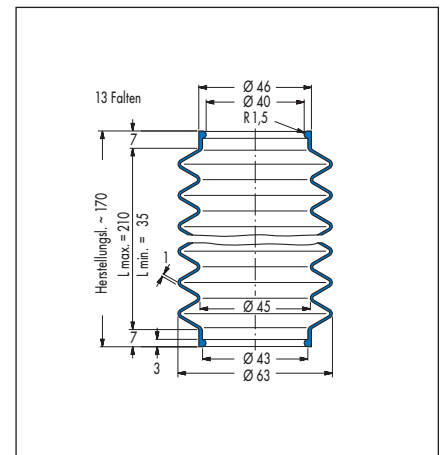

V6-00801, Artikel-Nr. 438557 (50 CR 879)/  
440760 (42 CR 764)

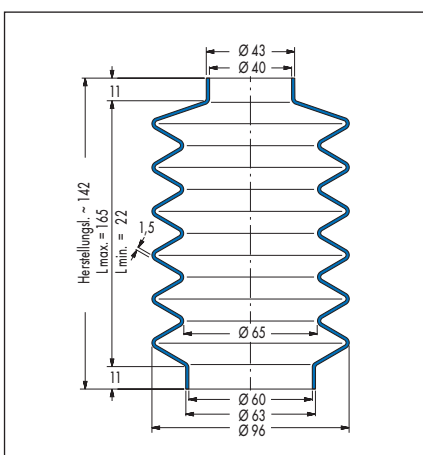

V6-00072, Artikel-Nr. 434088

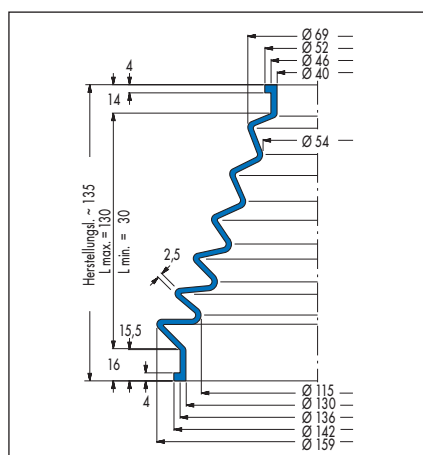

V6-00092, Artikel-Nr. 434425

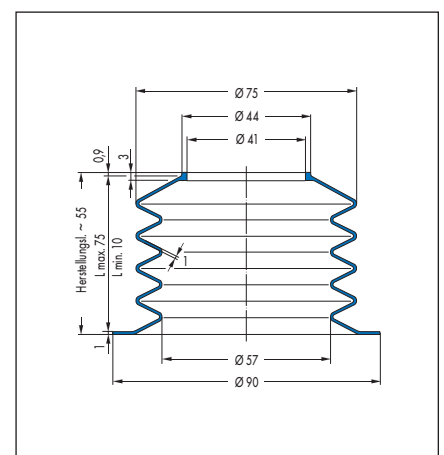

V6-00700, Artikel-Nr. 153008

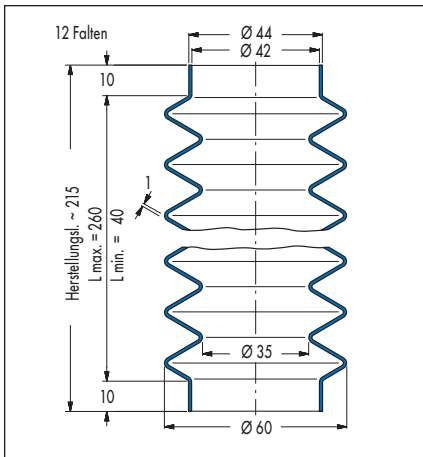

V6-00637, Artikel-Nr. 438549

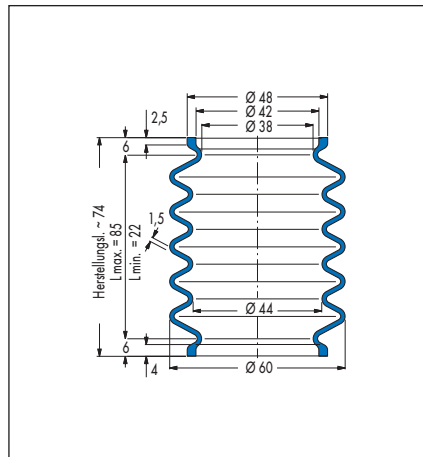

V6-00268, Artikel-Nr. 432119

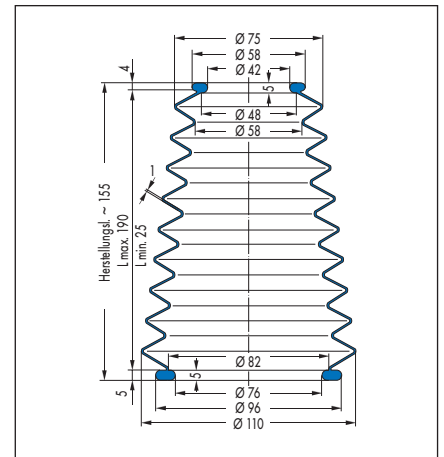

V6-00328, Artikel-Nr. 432424 (42 CR 764)/  
454213 (50 CR 879)

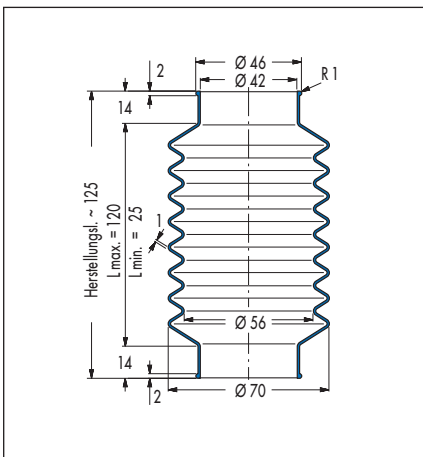

V6-00536, Artikel-Nr. 426801

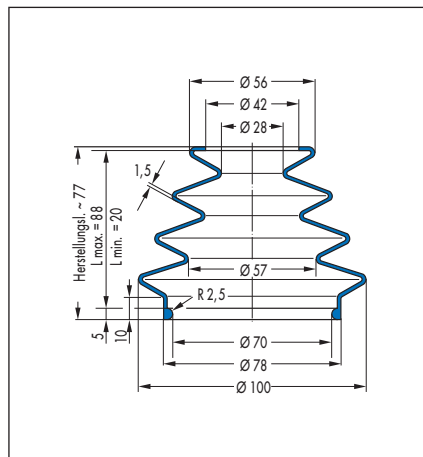

V6-20195, Artikel-Nr. 501096

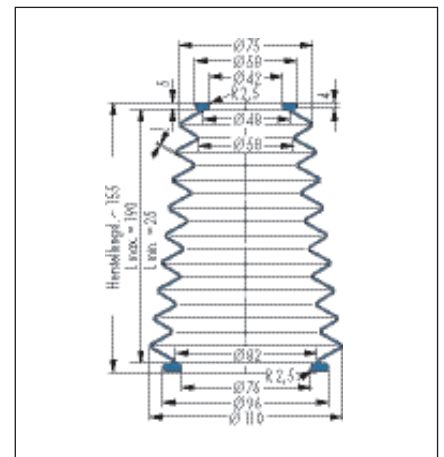

V6-00328, Artikel-Nr. 432424 (42 CR 764)/  
454213 (50 CR 879)

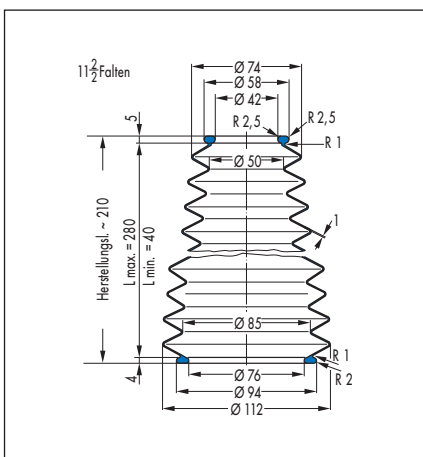

V6-00562, Artikel-Nr. 29741

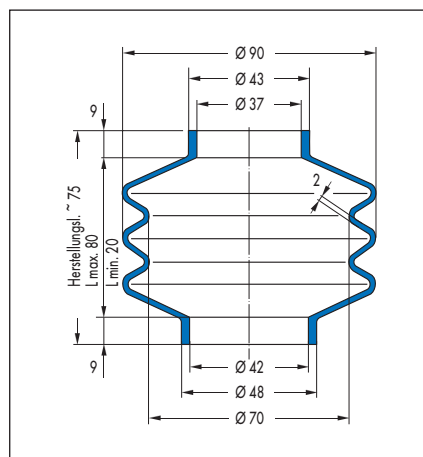

V6-01030, Artikel-Nr. 400918

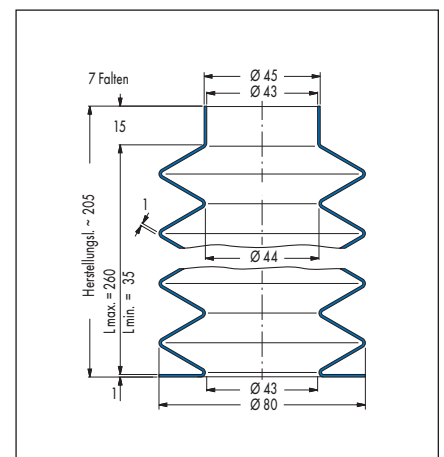

V6-00626, Artikel-Nr. 437270



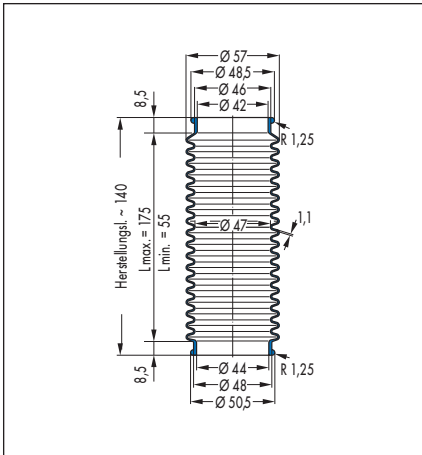

V6-00449, Artikel-Nr. 456484

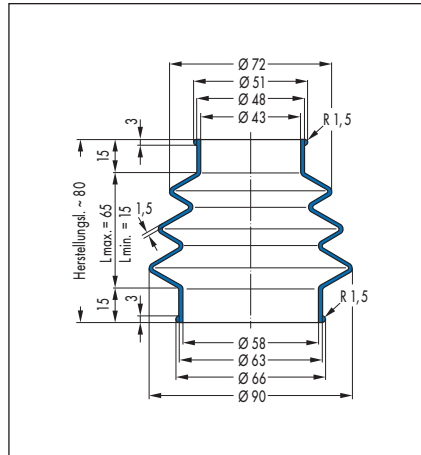

V6-00853, Artikel-Nr. 465751

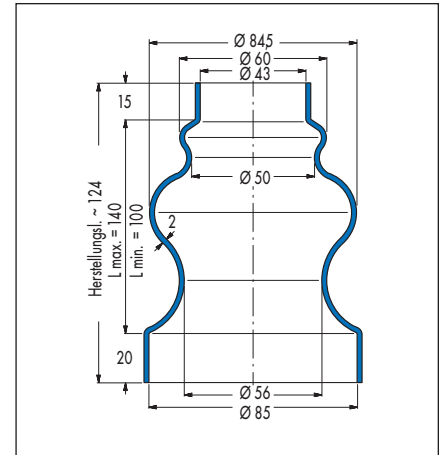

V6-00012, Artikel-Nr. 426317 (42 CR 764)/  
60032051 (45 NBR 670)

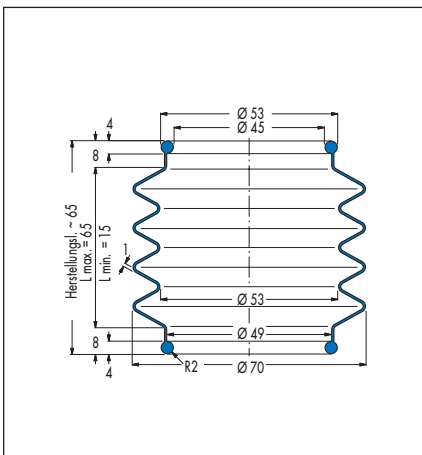

V6-00784, Artikel-Nr. 432192

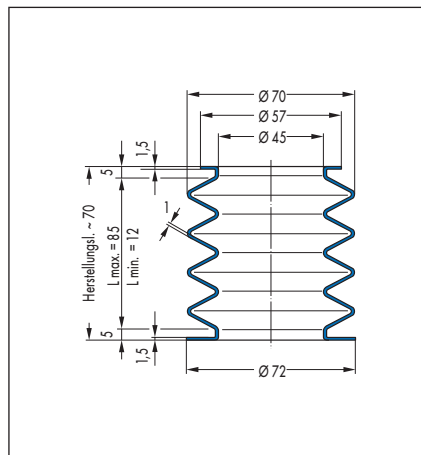

V6-00967, Artikel-Nr. 89513

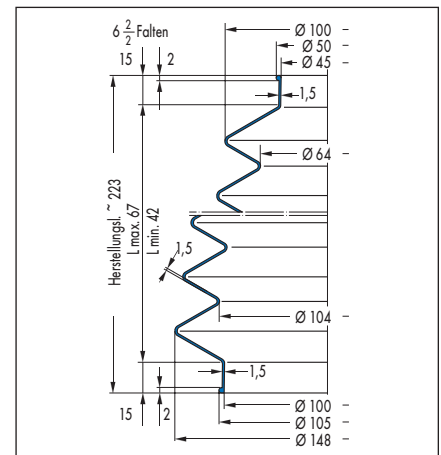

V6-01046, Artikel-Nr. 400920

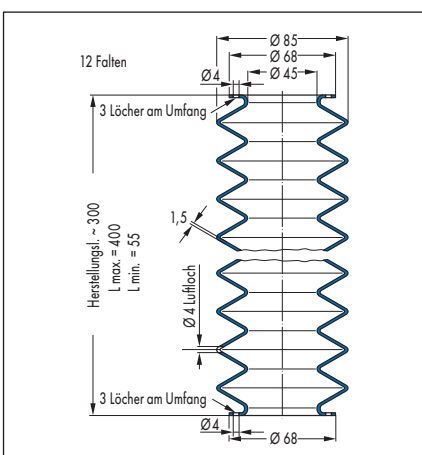

V6-01075, Artikel-Nr. 400934

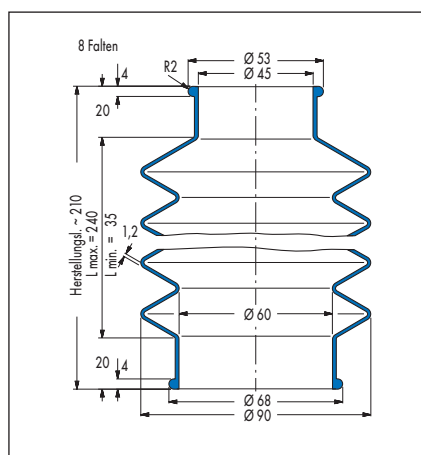

V6-00593, Artikel-Nr. 439497 (42 CR 764)/  
439499 (50 CR 879)

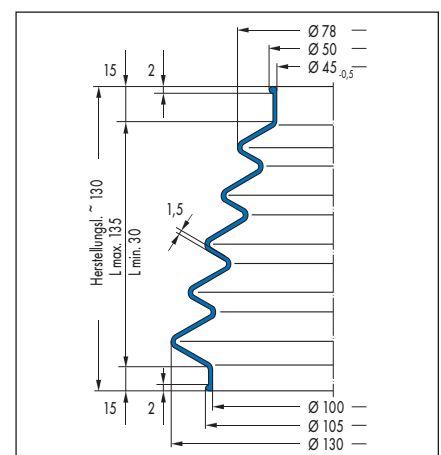

V6-01047, Artikel-Nr. 454226

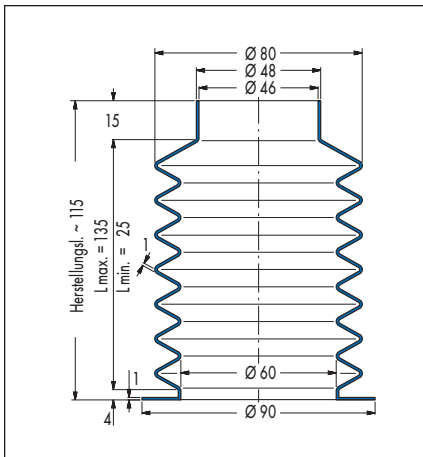

V6-00466, Artikel-Nr. 430847

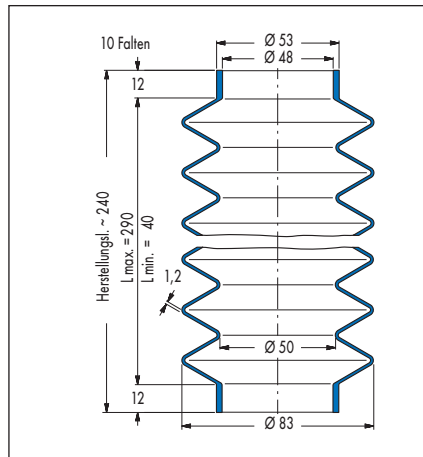

V6-01022, Artikel-Nr. 432696

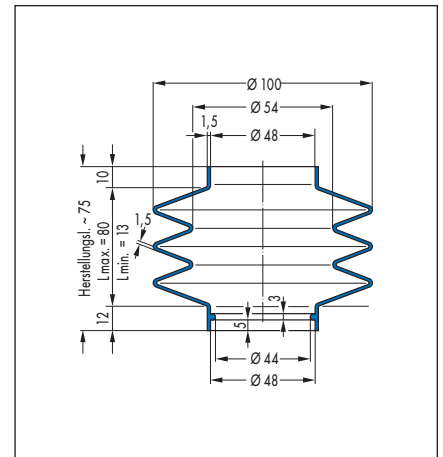

V6-01136, Artikel-Nr. 425266

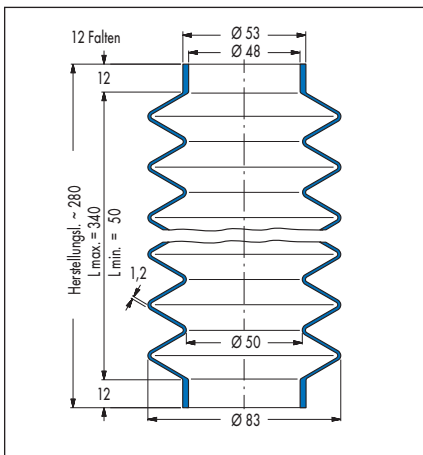

V6-01165, Artikel-Nr. 454248

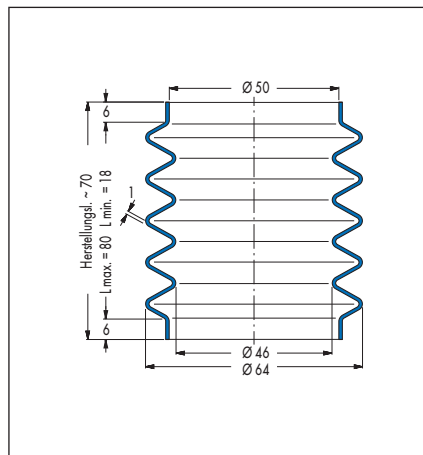

V6-00541, Artikel-Nr. 25105

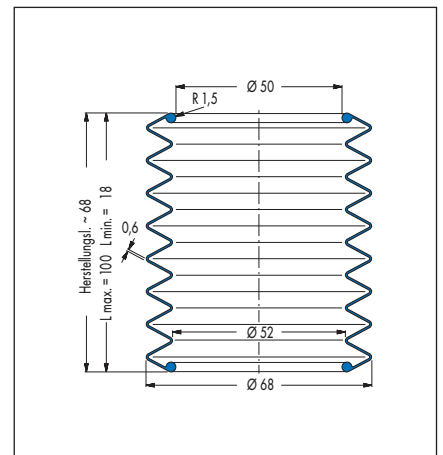

V6-00742, Artikel-Nr. 426388

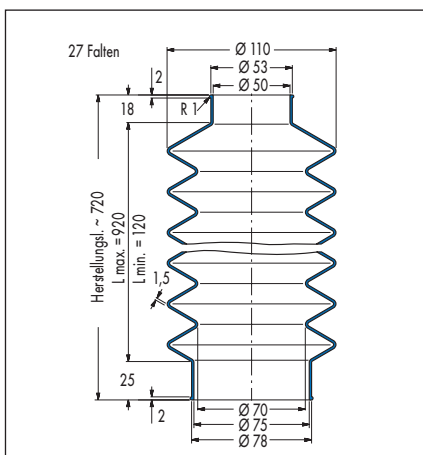

V6-00723, Artikel-Nr. 29915

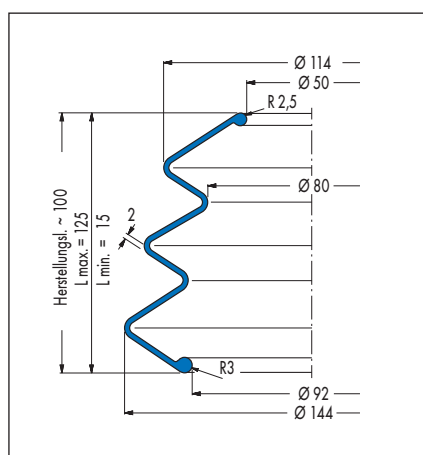

V6-00821, Artikel-Nr. 25235

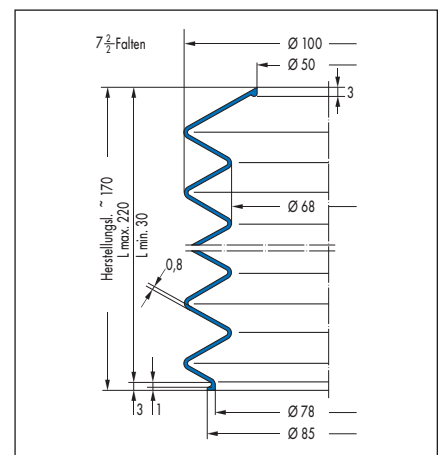

V6-01029, Artikel-Nr. 20231

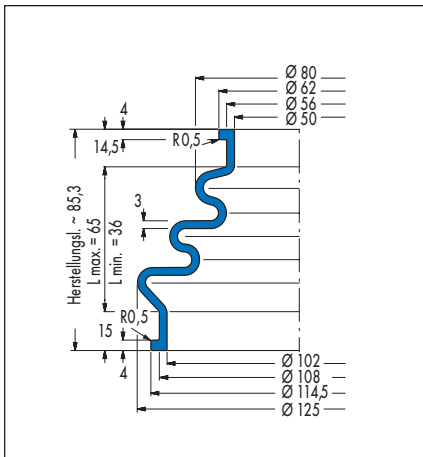

V6-00091, Artikel-Nr. 456482

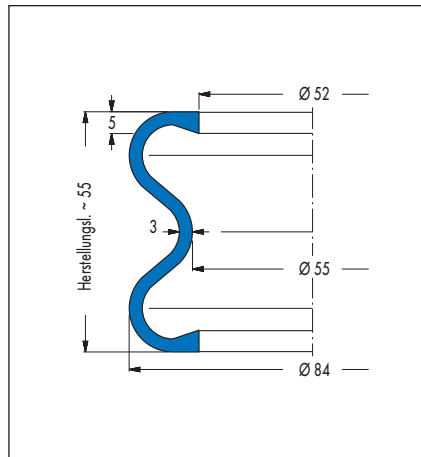

V6-00291, Artikel-Nr. 440381

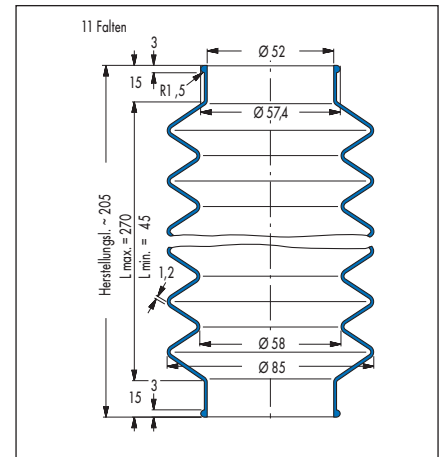

V6-00987, Artikel-Nr. 440232 (50 CR 879)/  
440233 (42 CR 764)

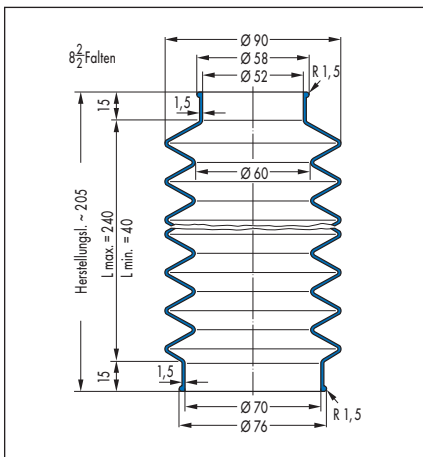

V6-00976, Artikel-Nr. 429665

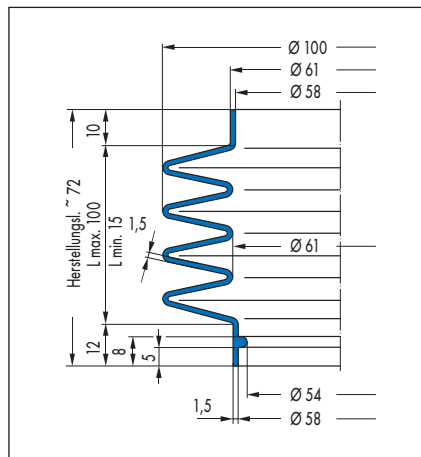

V6-01064, Artikel-Nr. 453735

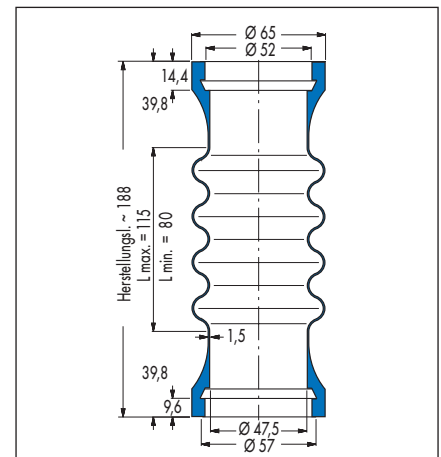

V6-00226, Artikel-Nr. 439437

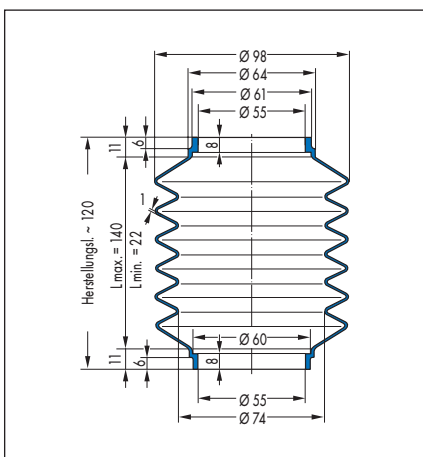

V6-00577, Artikel-Nr. 439496

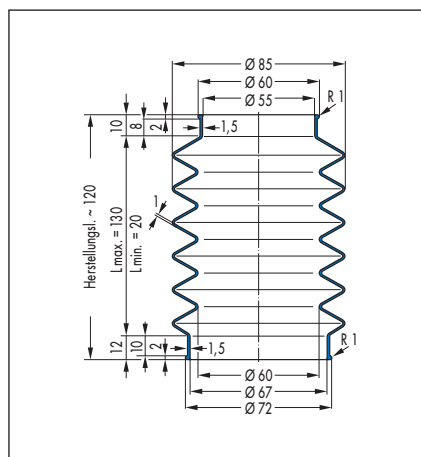

V6-00740, Artikel-Nr. 430860

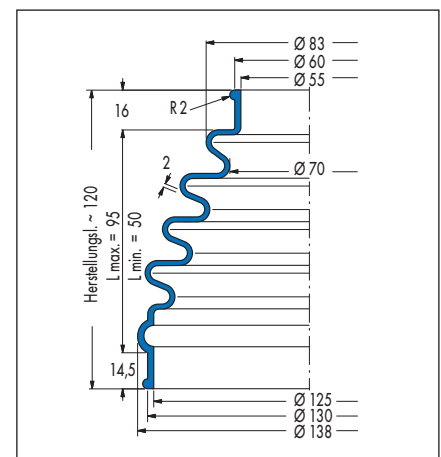

V6-00205, Artikel-Nr. 440285

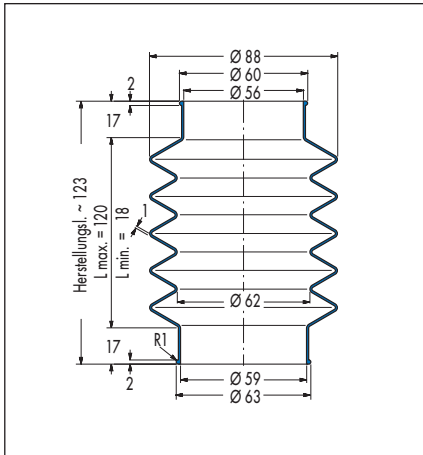

V6-00153, Artikel-Nr. 426797

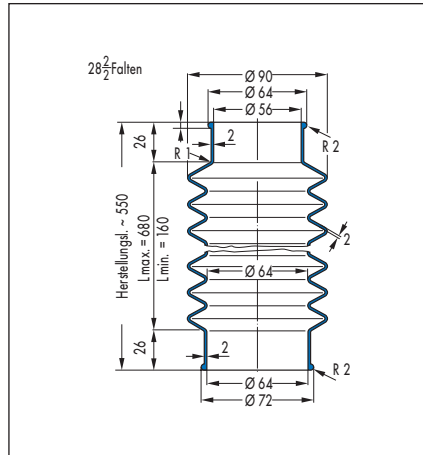

V6-00519, Artikel-Nr. 29705

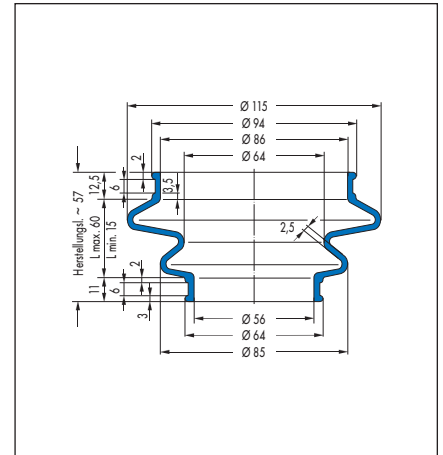

V6-00779, Artikel-Nr. 360138

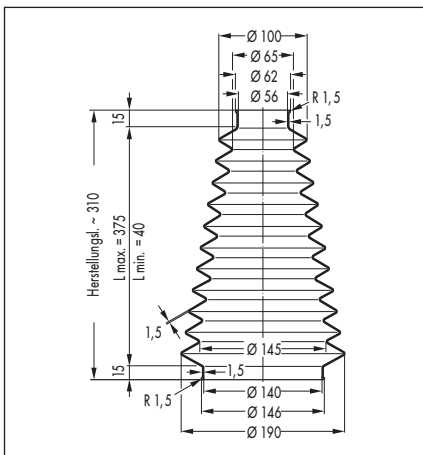

V6-00926, Artikel-Nr. 35807

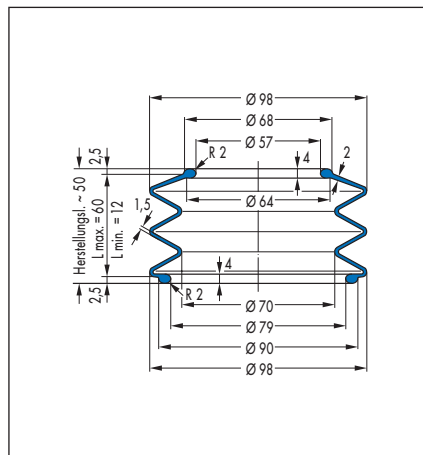

V6-01226, Artikel-Nr. 452566

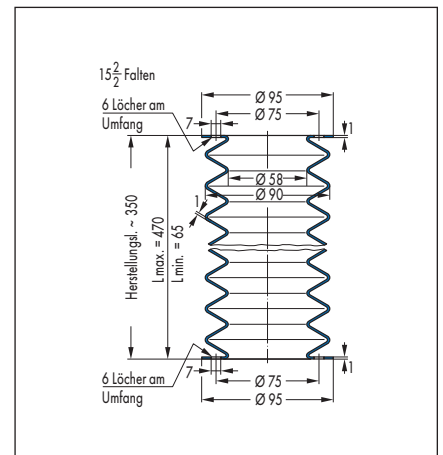

V6-00606, Artikel-Nr. 29774

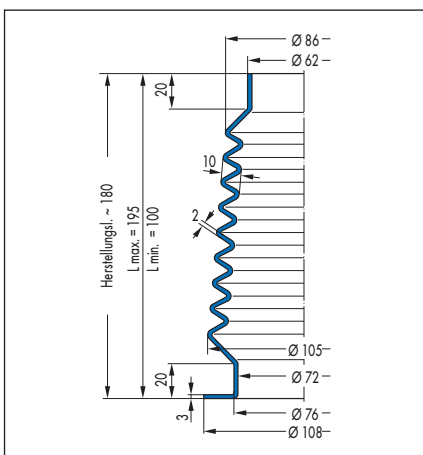

V6-00866, Artikel-Nr. 454218

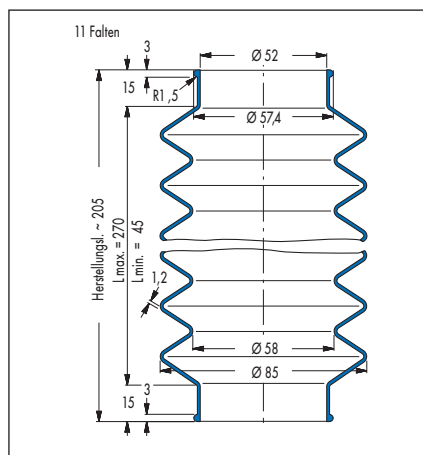

V6-00352, Artikel-Nr. 19577

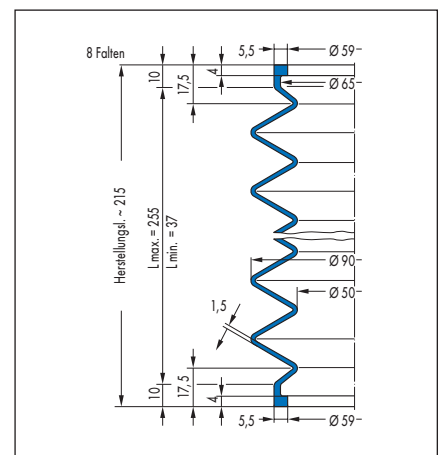

V6-00937, Artikel-Nr. 60022627

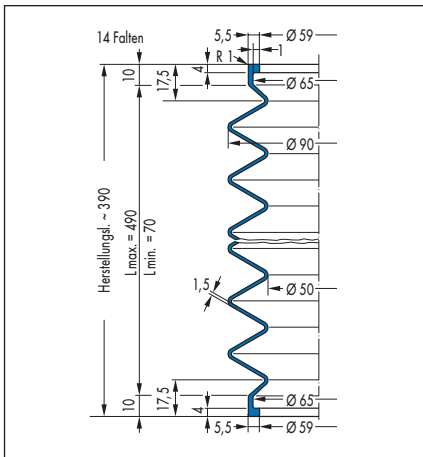

V6-00910, Artikel-Nr. 103132

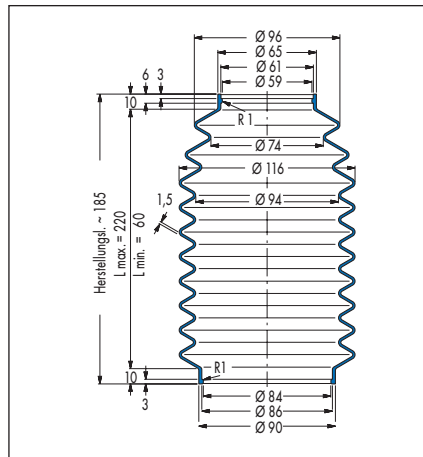

V6-01453, Artikel-Nr. 454255

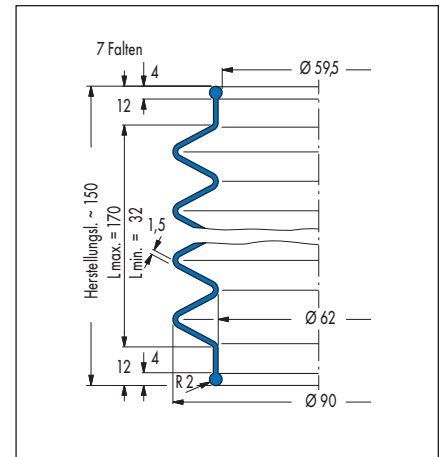

V6-00260, Artikel-Nr. 434071

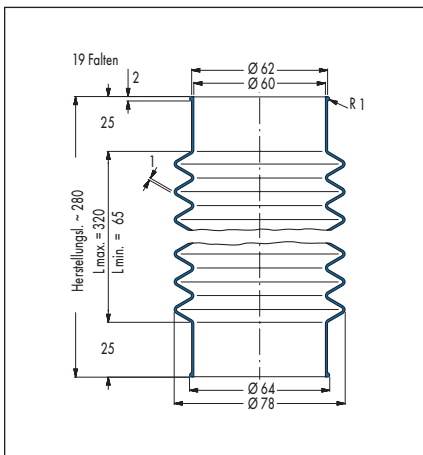

V6-00499, Artikel-Nr. 25090

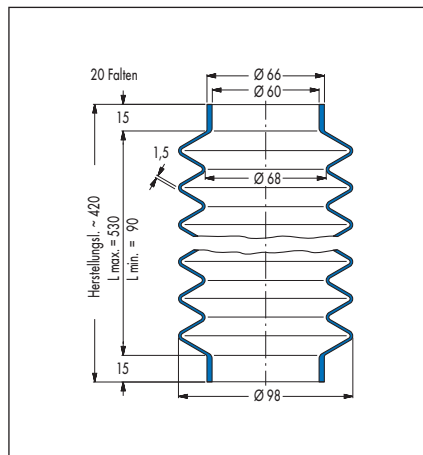

V6-00450, Artikel-Nr. 29652

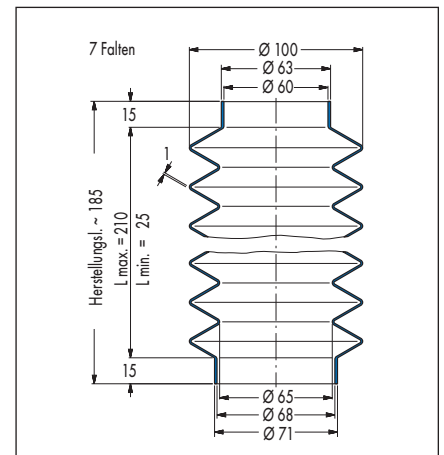

V6-00375, Artikel-Nr. 428321

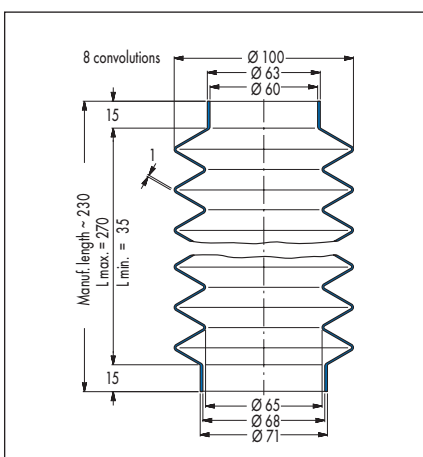

V6-00400, Artikel-Nr. 438535

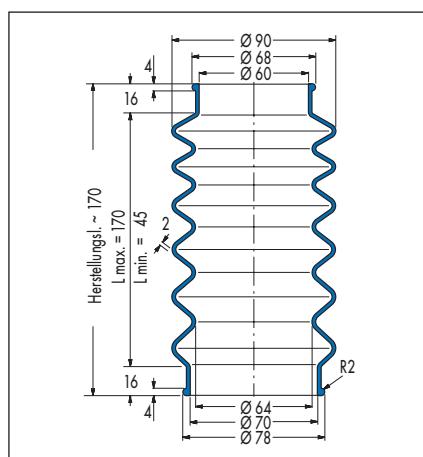

V6-00453, Artikel-Nr. 426371

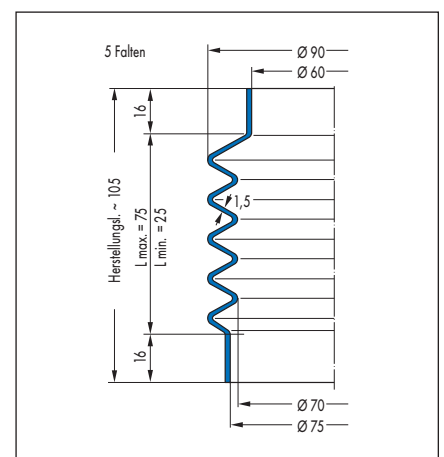

V6-01774, Artikel-Nr. 451414

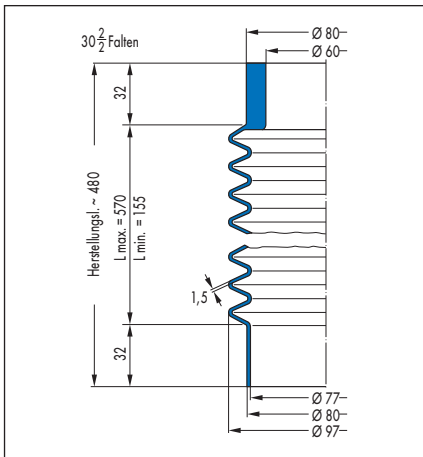

V6-01018, Artikel-Nr. 454225

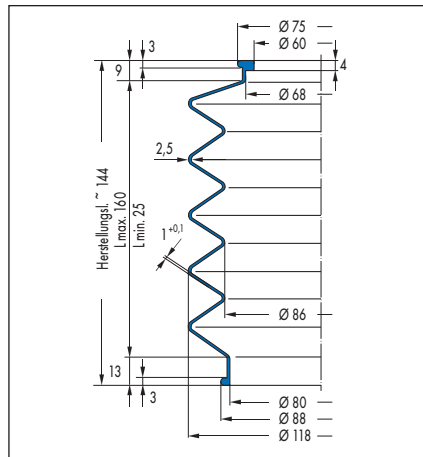

V6-01049, Artikel-Nr. 454227

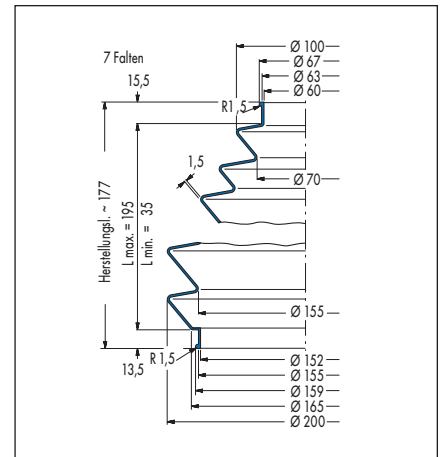

V6-00444, Artikel-Nr. 29643

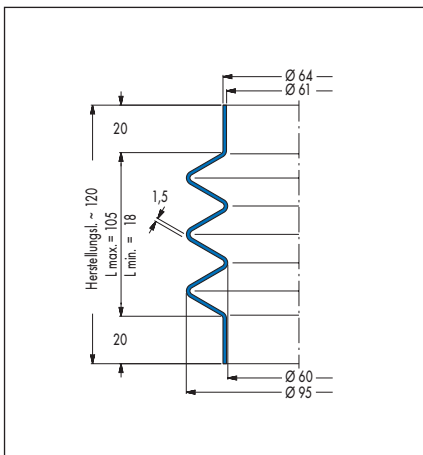

V6-00099, Artikel-Nr. 434091 (NBR)/  
434092 (CR)

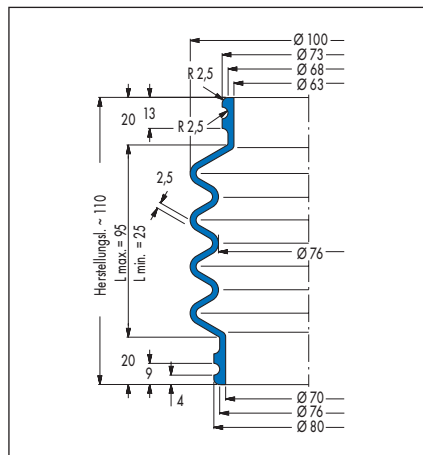

V6-00242, Artikel-Nr. 439438

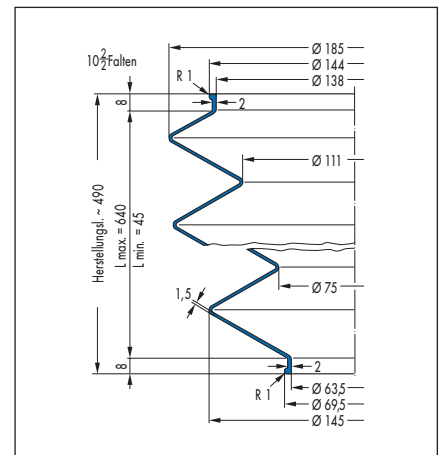

V6-00917, Artikel-Nr. 507015

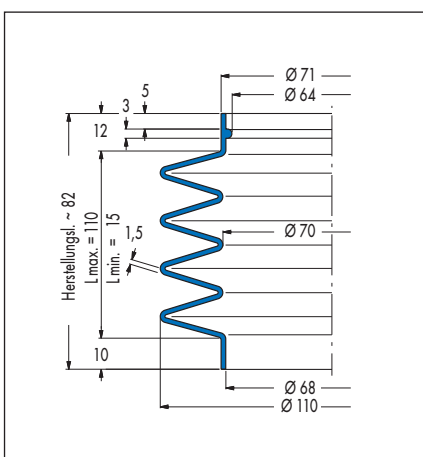

V6-01063, Artikel-Nr. 453733

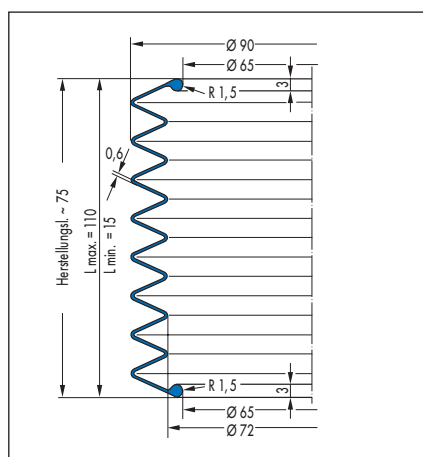

V6-00743, Artikel-Nr. 25159

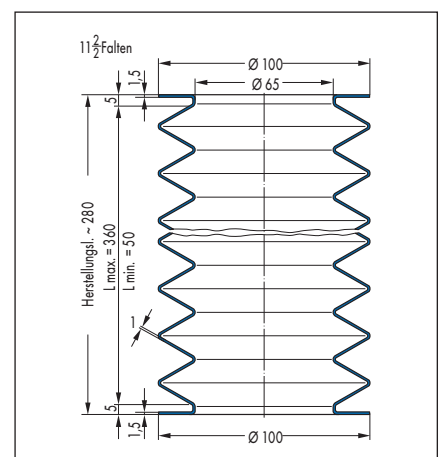

V6-00968, Artikel-Nr. 506619

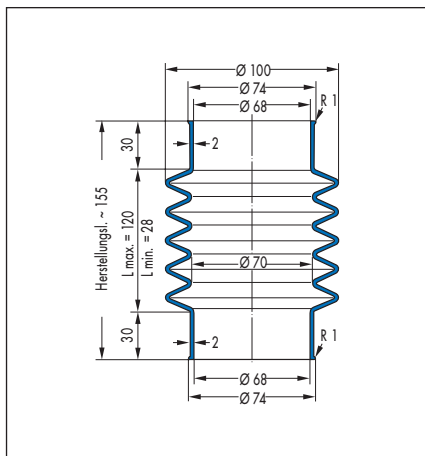

V6-00497, Artikel-Nr. 101244

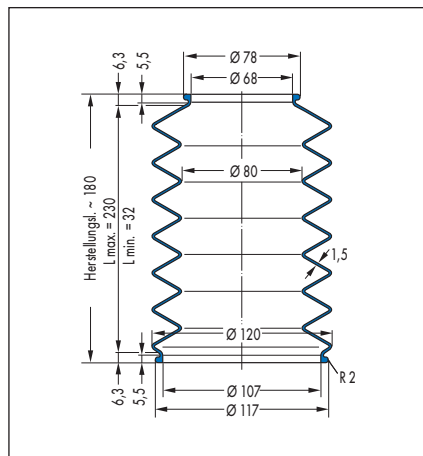

V6-00329, Artikel-Nr. 428309

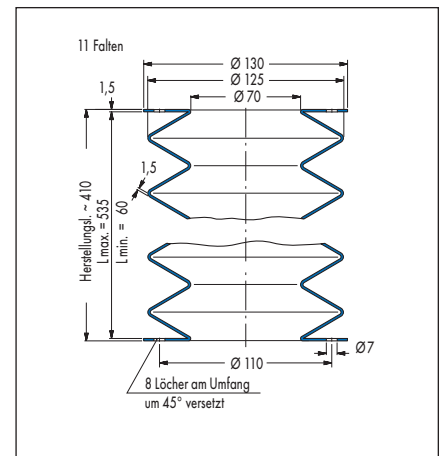

V6-00424, Artikel-Nr. 29620

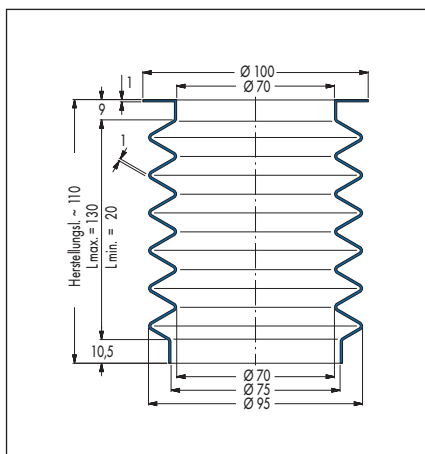

V6-00638, Artikel-Nr. 29803

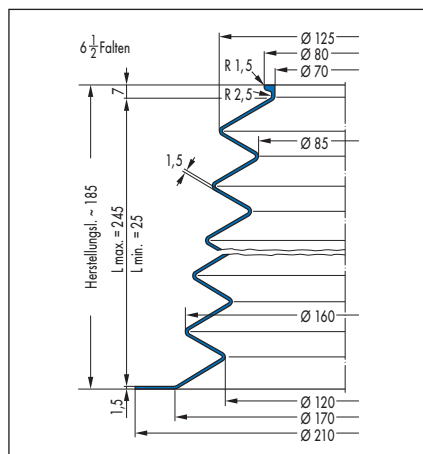

V6-01033, Artikel-Nr. 10596

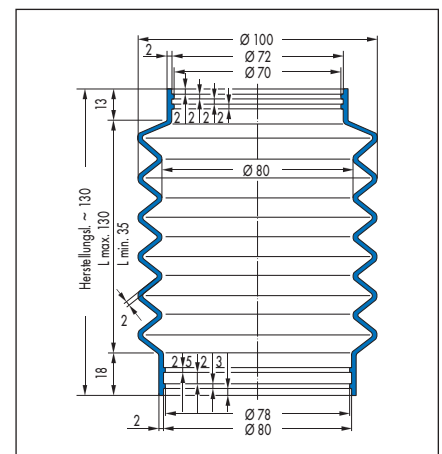

V6-00477, Artikel-Nr. 400709

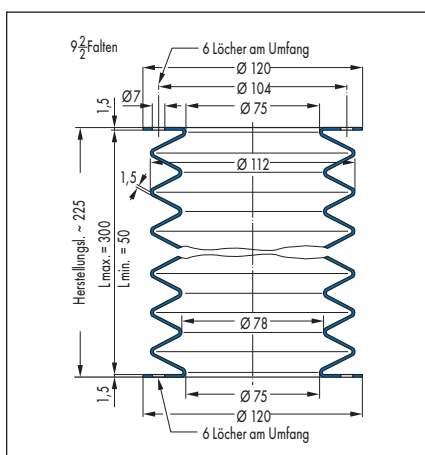

V6-00813, Artikel-Nr. 414718

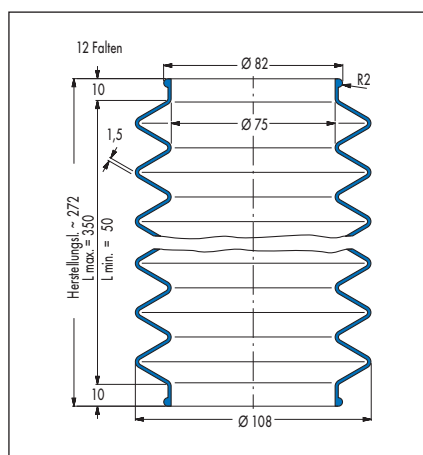

V6-00093, Artikel-Nr. 440343

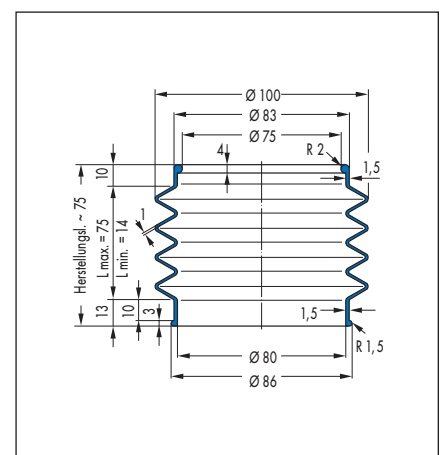

V6-00934, Artikel-Nr. 382212

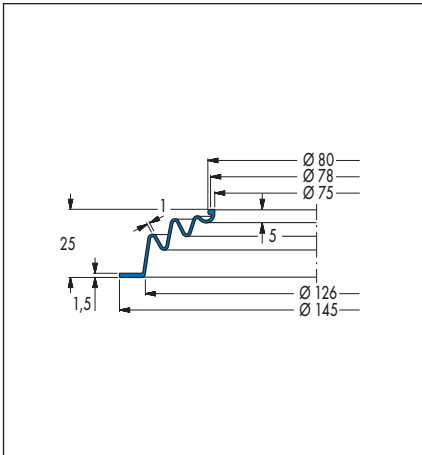

V6-00441, Artikel-Nr. 434020

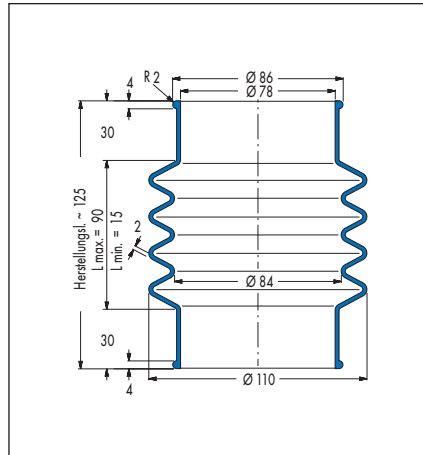

V6-00501, Artikel-Nr. 438944 (50 CR 879)/  
438946 (42 CR 764)

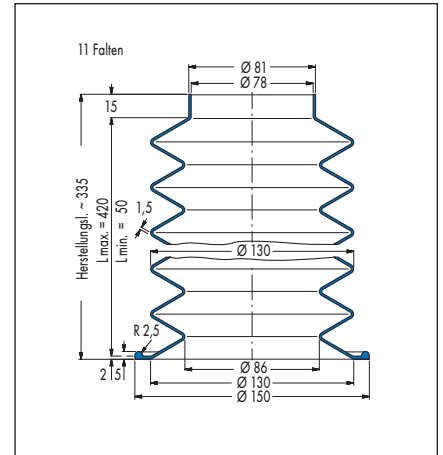

V6-00520, Artikel-Nr. 25100 (45 NBR 670)/  
307731 (50 CR 879)

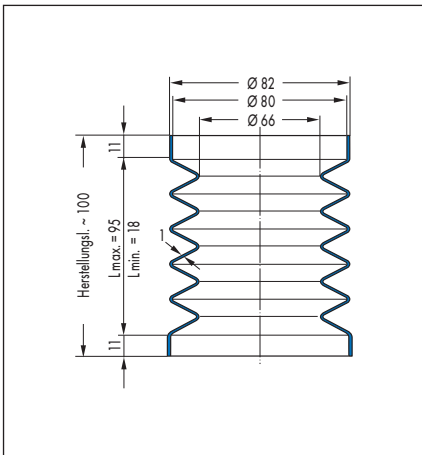

V6-00141, Artikel-Nr. 451746 (42 CR 764)/  
451747 (50 CR 879)

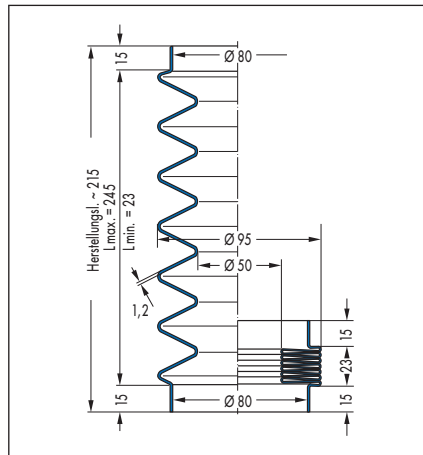

V6-00115, Artikel-Nr. 29283

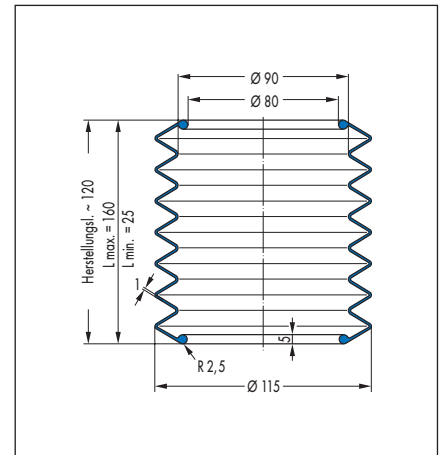

V6-01079, Artikel-Nr. 454232

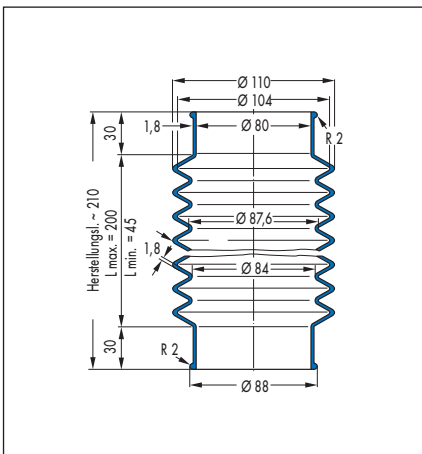

V6-00476, Artikel-Nr. 61279

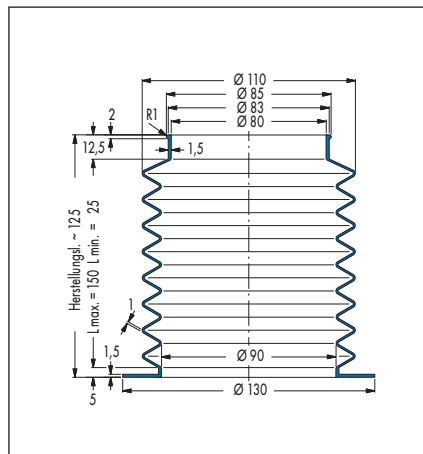

V6-00963, Artikel-Nr. 454221

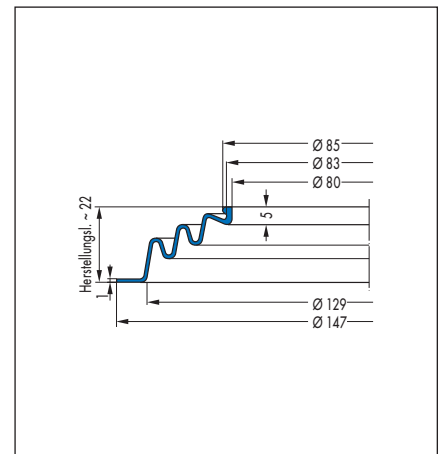

V6-00846, Artikel-Nr. 307856



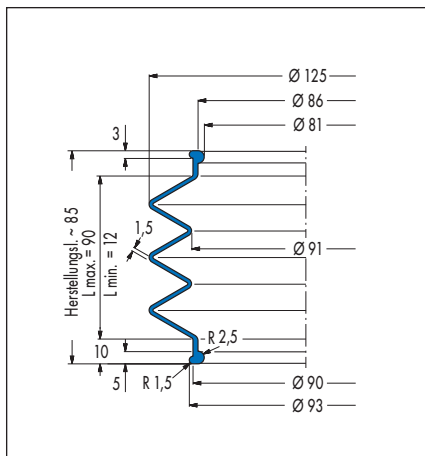

V6-00633, Artikel-Nr. 426324

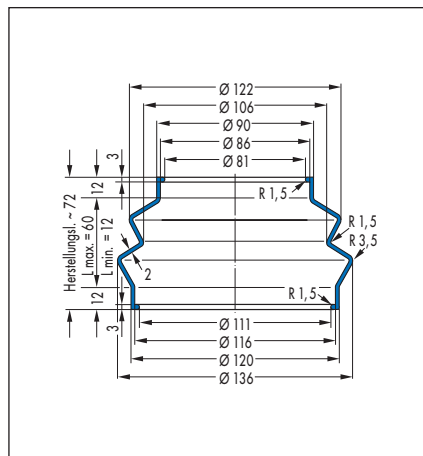

V6-00326, Artikel-Nr. 454212

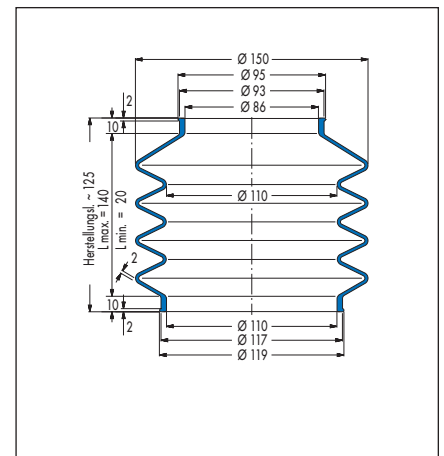

V6-00643, Artikel-Nr. 29807

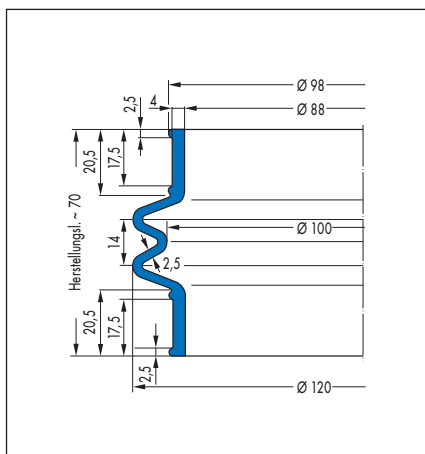

V6-01412, Artikel-Nr. 104484

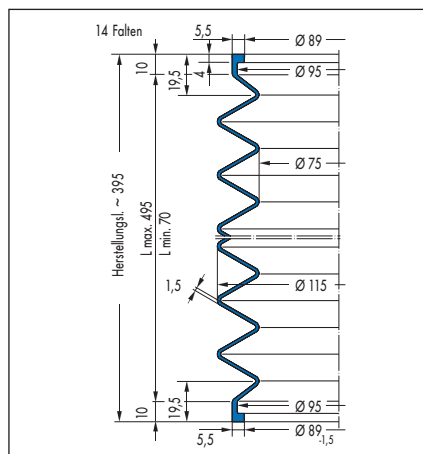

V6-00911, Artikel-Nr. 63487

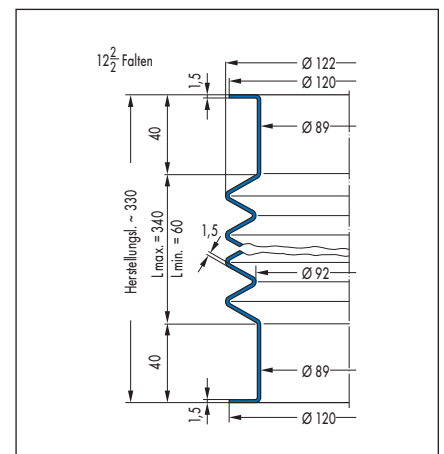

V6-00807, Artikel-Nr. 380578

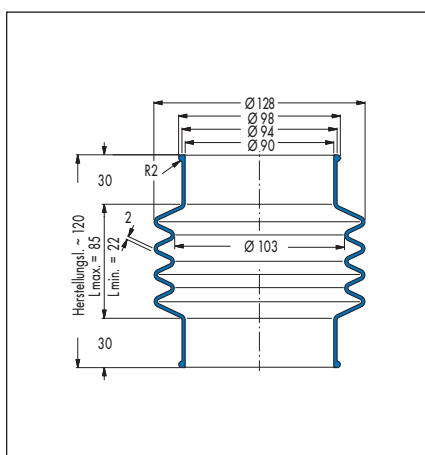

V6-00517, Artikel-Nr. 454473

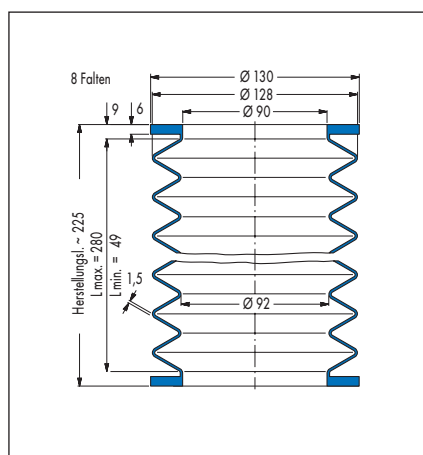

V6-00721, Artikel-Nr. 29912

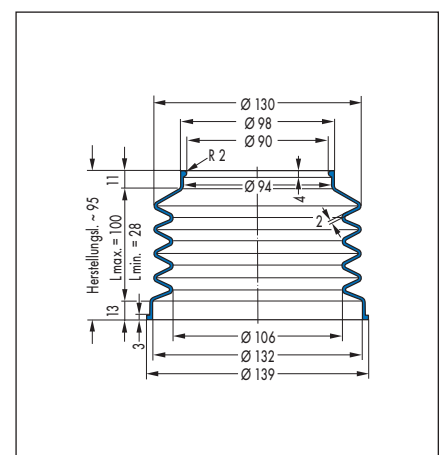

V6-00515, Artikel-Nr. 400735

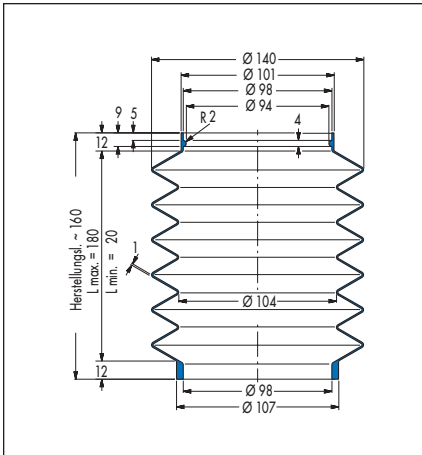

V6-01140, Artikel-Nr. 454240

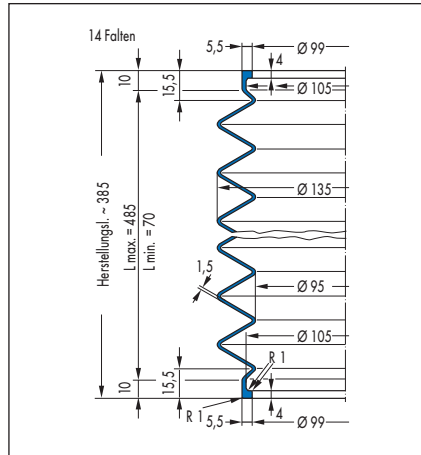

V6-00909, Artikel-Nr. 505424

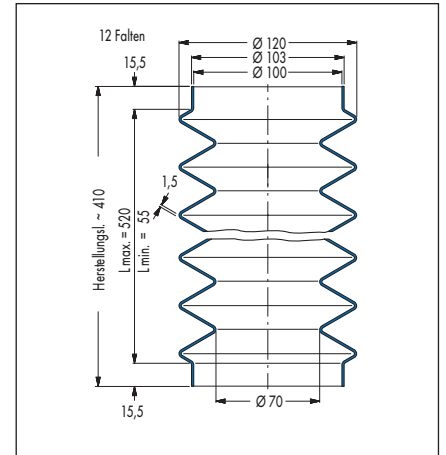

V6-00468, Artikel-Nr. 29675

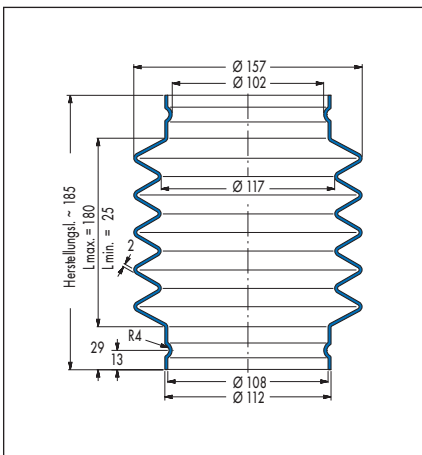

V6-00658, Artikel-Nr. 25144

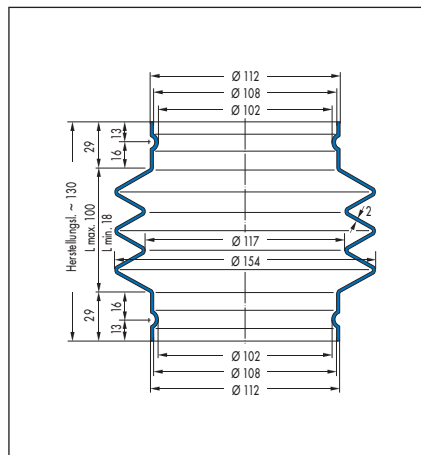

V6-00657, Artikel-Nr. 400791

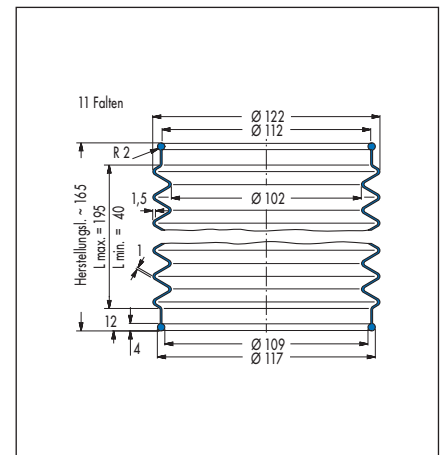

V6-00332, Artikel-Nr. 454470

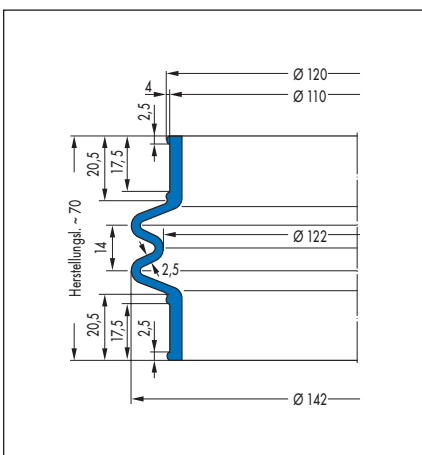

V6-01406, Artikel-Nr. 333285

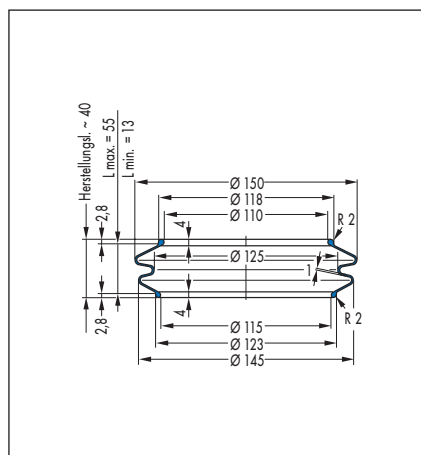

V6-00621, Artikel-Nr. 400783

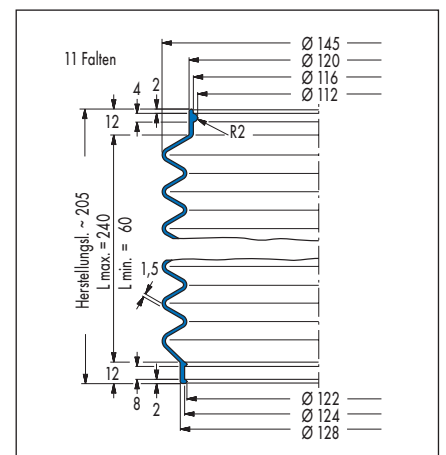

V6-01247, Artikel-Nr. 454251

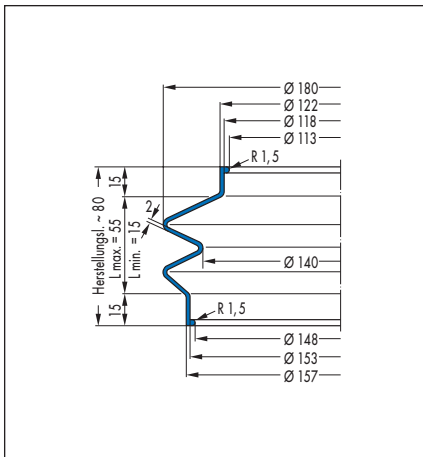

V6-00443, Artikel-Nr. 1065

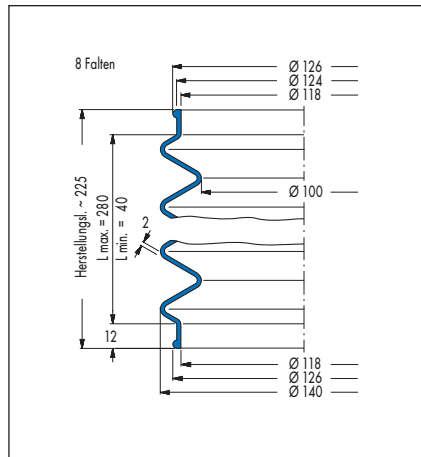

V6-00642, Artikel-Nr. 2708

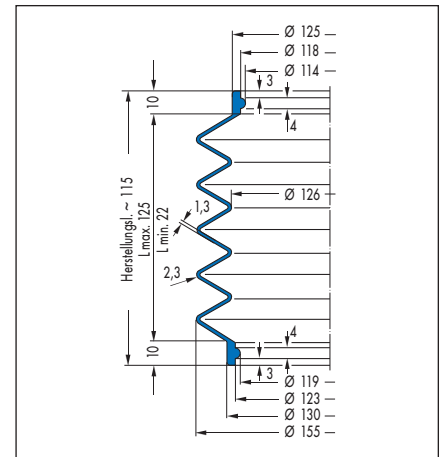

V6-01003, Artikel-Nr. 455224

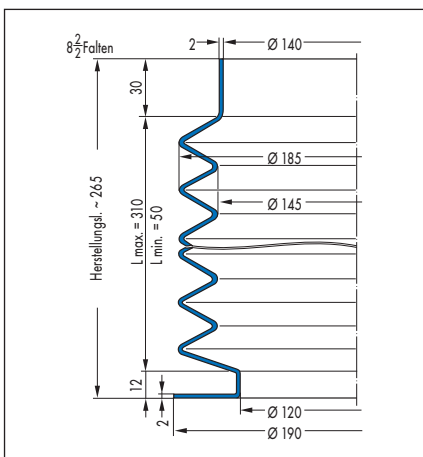

V6-00542, Artikel-Nr. 125325

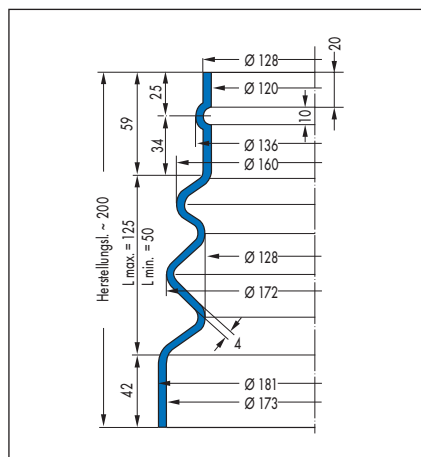

V6-00493, Artikel-Nr. 23442

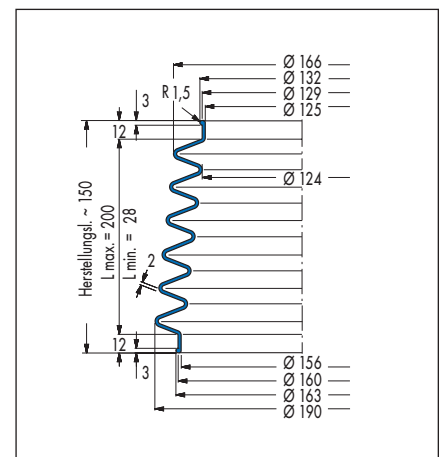

V6-00217, Artikel-Nr. 29370

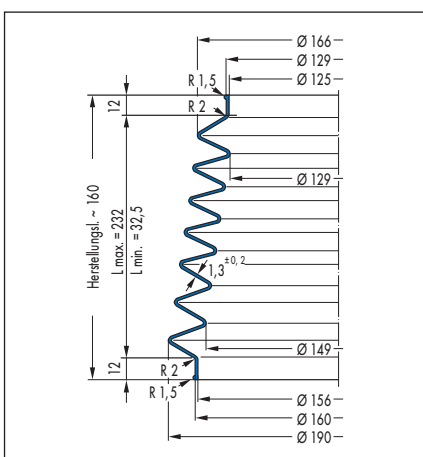

V6-01445, Artikel-Nr. 355400

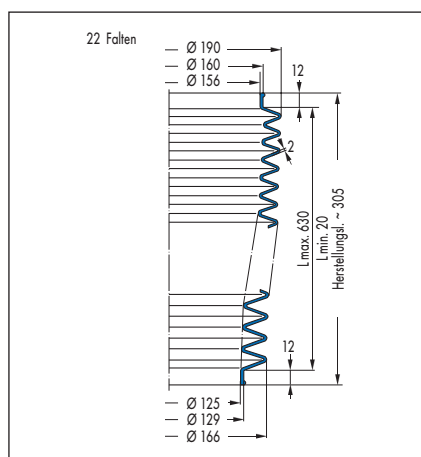

V6-01444, Artikel-Nr. 60040372

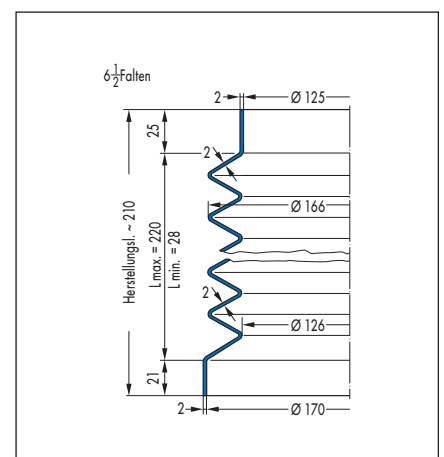

V6-00544, Artikel-Nr. 29726

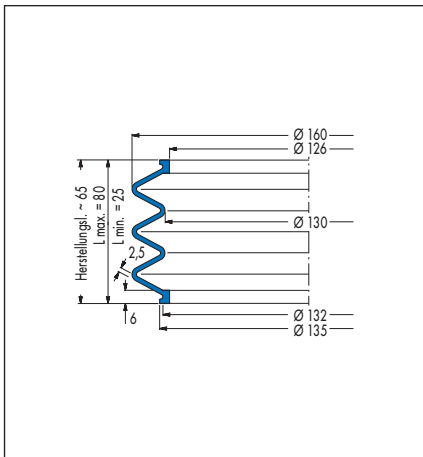

V6-00396, Artikel-Nr. 454471

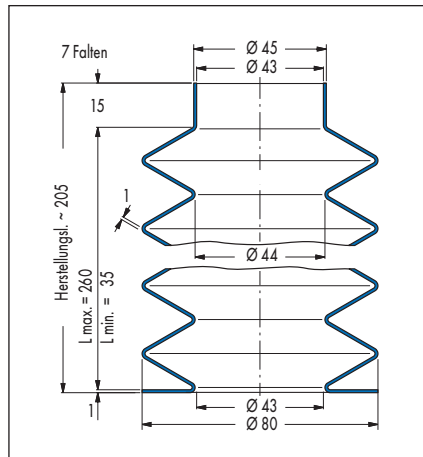

V6-00628, Artikel-Nr. 29793

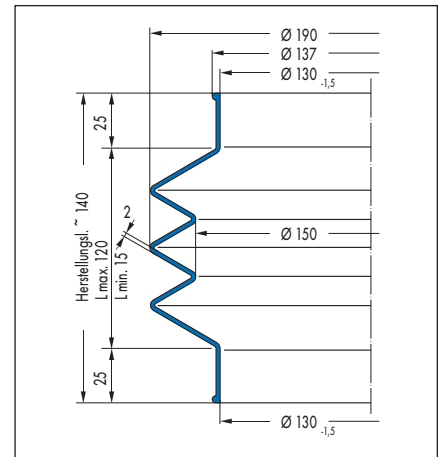

V6-01305, Artikel-Nr. 400958

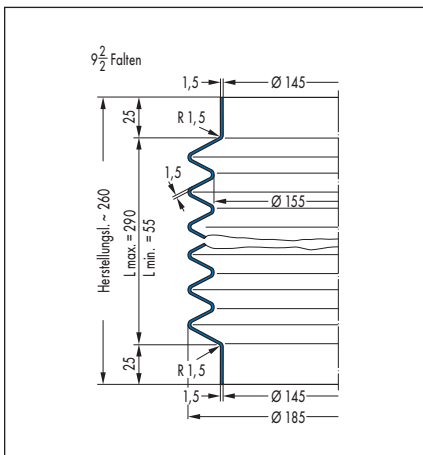

V6-00612, Artikel-Nr. 29778

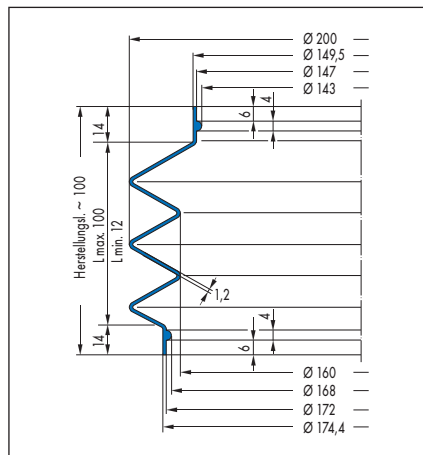

V6-00717, Artikel-Nr. 5050499

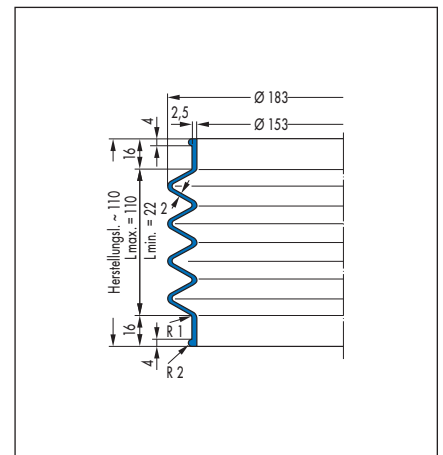

V6-00349, Artikel-Nr. 423911

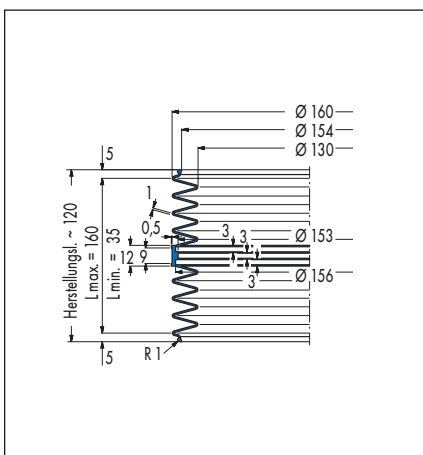

V6-00250, Artikel-Nr. 29416

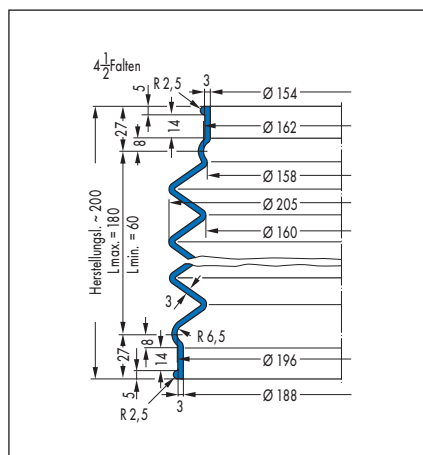

V6-00330, Artikel-Nr. 325674

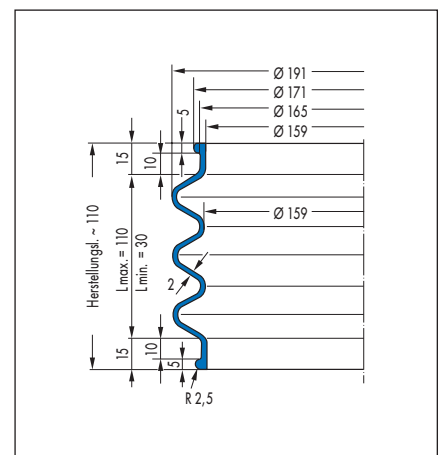

V6-00420, Artikel-Nr. 29612

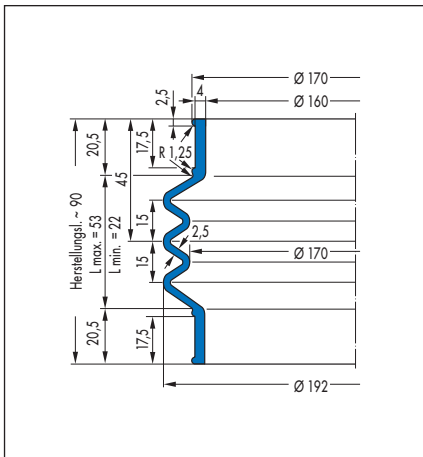

V6-01413, Artikel-Nr. 104556

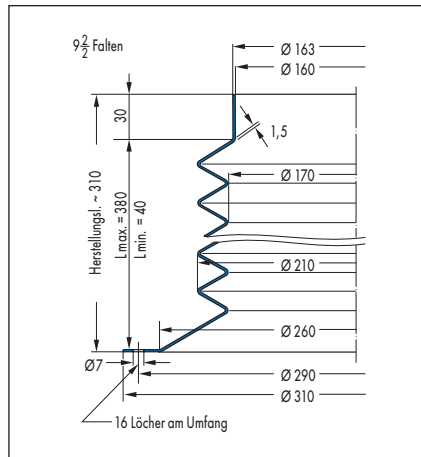

V6-00676, Artikel-Nr. 29842

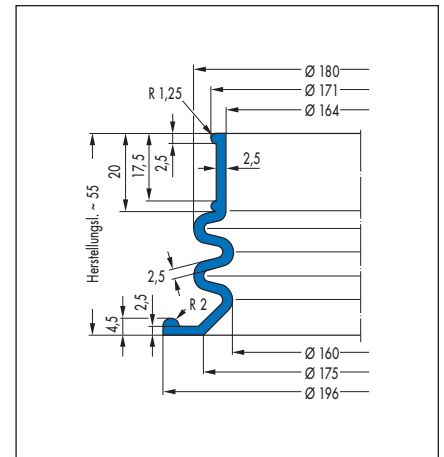

V6-01234, Artikel-Nr. 501406

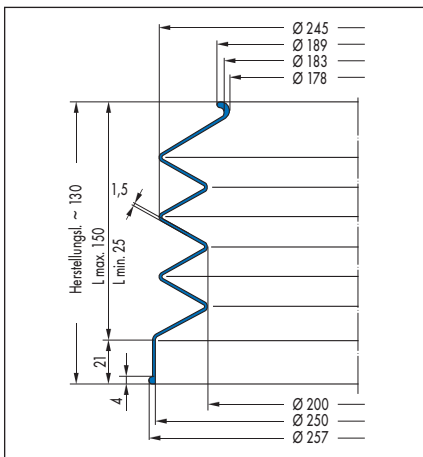

V6-00782, Artikel-Nr. 7509

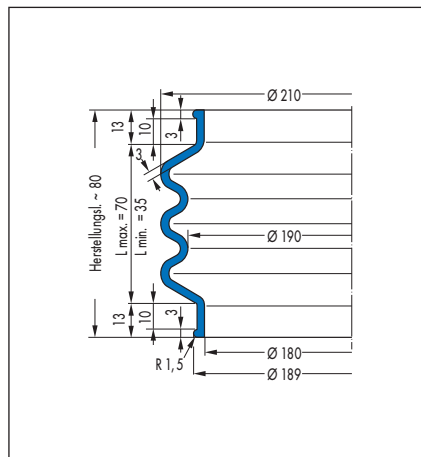

V6-00661, Artikel-Nr. 29824 (45 NBR 670)/  
60028128 (50 CR 879)

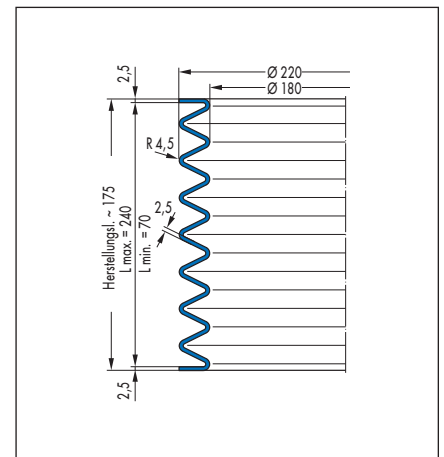

V6-00345, Artikel-Nr. 325185

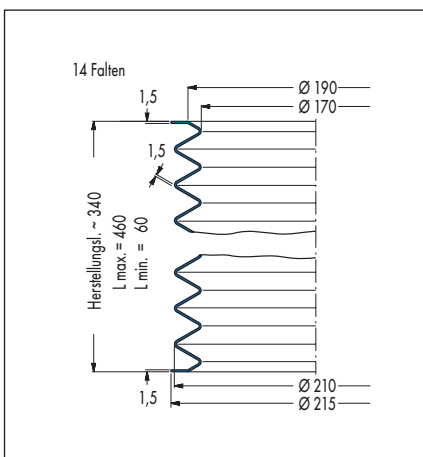

V6-00767, Artikel-Nr. 36413

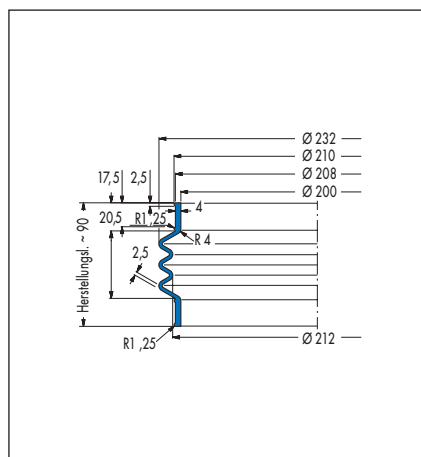

V6-01528, Artikel-Nr. 455421

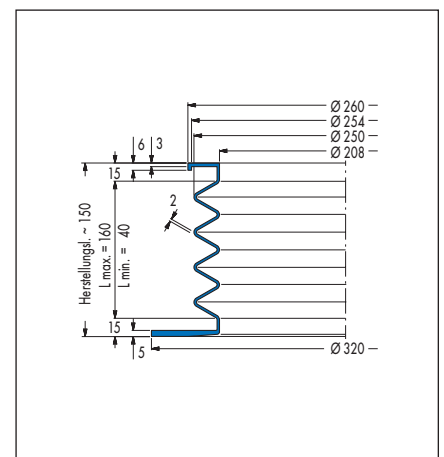

V6-00318, Artikel-Nr. 87072

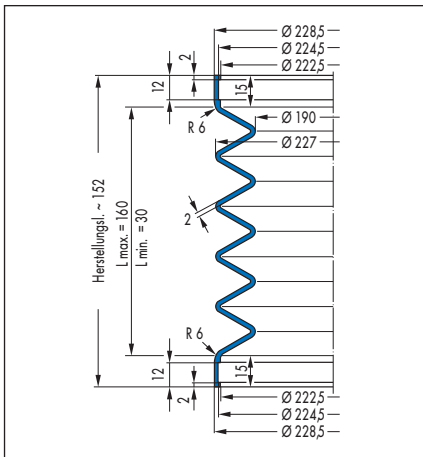

V6-01736, Artikel-Nr. 401008

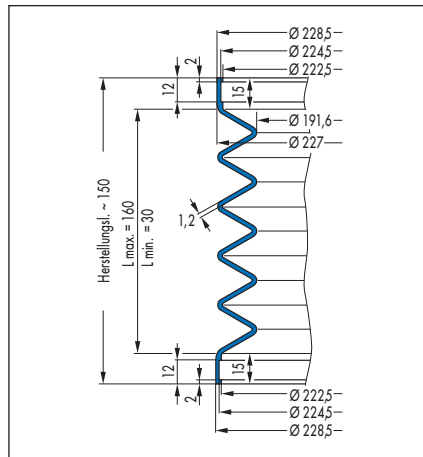

V6-01793, Artikel-Nr. 336447

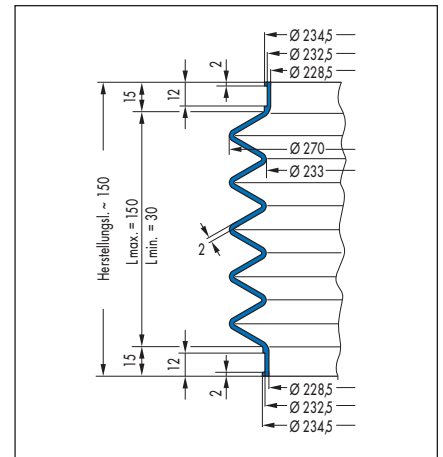

V6-01737, Artikel-Nr. 401009

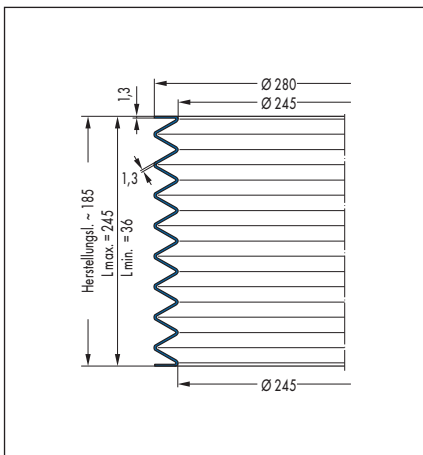

V6-00841, Artikel-Nr. 6473

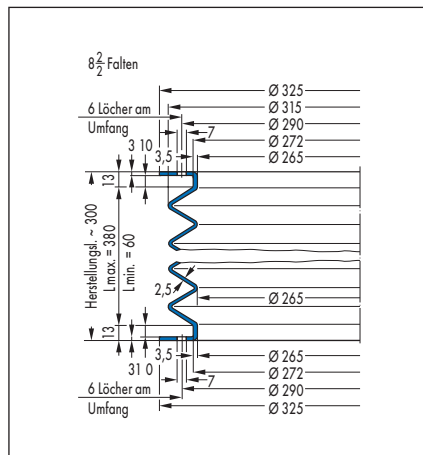

V6-00632, Artikel-Nr. 506890

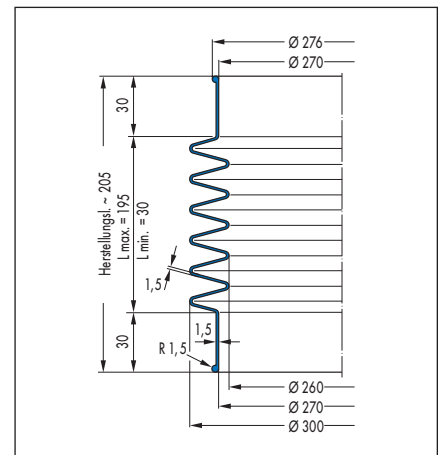

V6-01031, Artikel-Nr. 361913

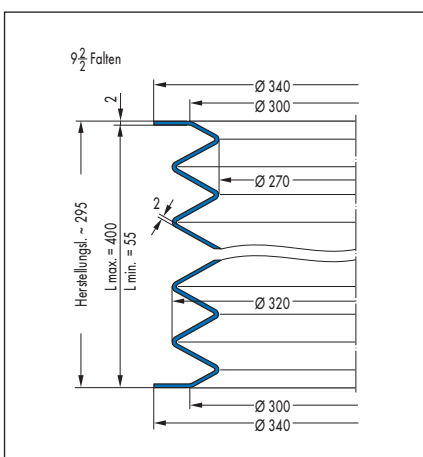

V6-00766, Artikel-Nr. 36412

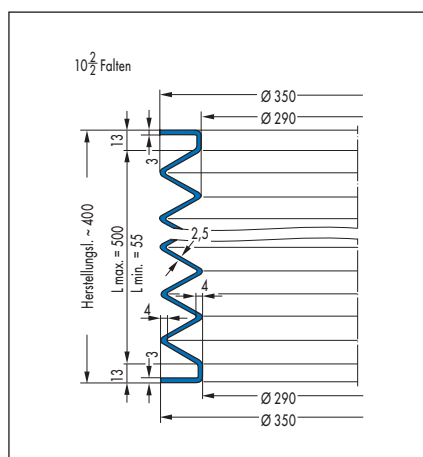

V6-00732, Artikel-Nr. 510580